

**March 2025**

# WEARPARTS CATALOGUE

**HUGE RANGE - GREAT PRICES - GREAT SERVICE**

**AUSTRALIA WIDE DELIVERY**



Standard replacement wearparts  
and **tungsten carbide hard faced wearparts**  
for

## AGRICULTURE, HORTICULTURE, VITICULTURE



Rotary Hoe Blades  
Power Harrow Blades  
Ripper Shanks & Assemblies  
Plough Discs & Coulters  
Points & Sweeps  
Mulching Hammers  
Flail Blades  
Forestry Mulcher Wearparts  
Wood Chipper Blades  
Slasher Blades  
Stump Grinding Teeth & Holders  
Aerator Tines  
Horizontal Grinder Wearparts  
Custom Hardfacing Service  
Custom Castings & Forgings  
Fasteners & U-Bolts

## FORESTRY, ARBORIST, MULCH, CHIP, GRIND



## DRILLING, TRENCHING



**[www.atcgroup.com.au](http://www.atcgroup.com.au)**

**PH: 07 3285 7777**

**MOB: 0448 588 433**

**EMAIL: [paul@atcgroup.com.au](mailto:paul@atcgroup.com.au)**





## About ATC Group

ATC GROUP head office is located in Brisbane Australia. For over two decades we have been one of Australia's most respected component and wearparts manufacturers. Our reputation as Australia's premier hard facing and custom wearpart company has resulted in wearpart sales into NZ, Canada, USA, and the UK. Allocating a percentage of turnover to R & D projects enable us to continually develop and improve our parts and procedures. Our relationships with Australian agricultural companies has grown over the years as customers realise the ATC GROUP philosophy is simple... we do what we say – every time!

We are genuinely dedicated to what we do. Our team, including engineers, metallurgists and professional welders are always keen to assist with the development of new parts, concepts and procedures. We are always undertaking trials and making prototypes for trialling with our customers. We are more than just a wearparts supplier. We develop, trial and strive to continually improve wearparts for our customers.

### CATALOGUE QUICK SEARCH FEATURE

## Catalogue Contents

Rotary hoe blades	Pages 5-10
Power harrow blades	Pages 11-12
Ripper legs, ripper points, aerator tines	Pages 13-16
Plain, scalloped, fluted labrador discs	Pages 17-28
Coulters	Pages 29-32
Agricultural points & sweeps	Pages 33-40
Mulching hammers	Pages 41-48
Mulching flail blades	Pages 49-54
Forestry mulcher inserts & holders	Pages 55-67
Wood chipper blades	Pages 68-70
Slasher blades	Pages 71-74
Stump Grinding	Pages 75-81
Fasteners & U-Bolts	Pages 84-85

How to use the quick search feature. Simply hold down the "ctrl" key and press "F" for FIND.

A search tool box will appear. Type into the search box what you are looking for, for example "Nobili" and the search feature will display every mention of the word "Nobili" within the parts catalogue :) Quick and easy!

If you cannot find what you are looking for please contact ATC. We will always try to help you.

Phone: 07 3285 7777 or Mobile 0448 588 433

Email: [sales@atcgroup.com.au](mailto:sales@atcgroup.com.au) WEB [www.atcgroup.com.au](http://www.atcgroup.com.au)

## **Tungsten carbide hardfacing specialists**



ATC are importers and wholesalers of Italian and Spanish manufactured wearparts made from quality European boron steel. ATC can supply standard replacement parts direct from the manufacturer to end users Australia wide and can supply our wearparts with additional tungsten carbide hardfacing or tungsten tile resulting in the longest wearing parts available in Australia today.

Cultivation by its very nature is abrasive and wearpart expenses, unlike commodity prices and rainfall only seem to go one way. The use of tungsten tiles, overlay, hardfacing wires and rods definitely increases the wear life of ground engaging parts.

The problem is - at what cost?

1. Many tungsten overlay companies charge so much your 1st square inch is worth as much as your point.
2. It wears well but increased drag means you need a dozer to pull your rig. Not to mention fuel costs.
3. Tiles fall off, break off, crack, splinter and split. When they do stay on, the point washes away everywhere else and the tile is left without a tip to protect.
4. More often than not you pay for twice the coating that you really need and end up throwing away hard earned dollars. If you have tried or are using someone else for your wear protection – contact us and we will discuss what you actually need, rather than what makes us the most money.

We will determine:

1. What your actual wear issues are.
2. Your environment – whether ATC tiles or ATC overlay or a combination may suit your needs. We consider every aspect ensuring we don't create too much drag. We generally don't use tiles in rocky country. When we do, we use a composite that can withstand rock impact.

We will visit if possible. If not us - we have close ties with 1 independent company in each Australian state that is privy to the same methods we use and has access to our castings and forgings at greatly reduced rates. We will give you a free trial of our product – that will work better than our competitors. Our aim is to supply quality wearparts and save you money and reduce your time and labour costs by you not having to change out wearing parts anywhere near as often.

**Phone: 07 3285 7777 or Mobile 0448 588 433**

**Email: [sales@atcgroup.com.au](mailto:sales@atcgroup.com.au) WEB [www.atcgroup.com.au](http://www.atcgroup.com.au)**



A large proportion of the products ATC supply are sold with ATC's tungsten carbide overlay. With over 20 years experience and expertise our hardfacing technique more than doubles the life of wearing components. ATC also manufactures custom parts and provide hardfacing solutions based on the needs of our customers.



Contact Paul on Phone **07 3285 7777** or mobile **0448 588 433** or Email **paul@atgroup.com.au** for your wearpart requirements.



## Rotary Hoe Blades, Cultitiller Tines & Power Harrow Blades

ATC supply standard replacement boron blades and tungsten carbide hardfaced blades for fitment in abrasive conditions such as sandy soils, granite country, and abrasive soil types. ATC tungsten carbide hardfaced blades can be utilised for fitment behind wheel tracks to reduce the need to change out worn blades as often.

ATC's hardfacing process of rotary hoe blades is unique. The placement of ATC's hardfacing enables the blade to wear sharp. ATC's tungsten carbide hardfacing will not break away from the blade, resist impact, and guarantee that you will more than double the life of the blade.

ATC's tungsten carbide hardfaced hoe blades are being used by some of the largest farming entities in the country and are tried, tested, and highly regarded by our ever growing number of customers.

Pictured right; ATC's hardfaced Boron hoe blade undergoing trial compared to non hardfaced Boron blades which can be seen in the back ground completely worn to sharp points. The ATC blade has yet to wear through the tungsten carbide hardfaced section.



**Replacement Boron blades with the option of tungsten carbide hardfacing for Agrator, Breviglieri, Celli, Falc, Howard, Krone, Kuhn, Lely, Maschio, Massano, Sicma, Tortella, Valentini and Wecan rotary hoes, bed formers and power harrows.**

ATC rotary hoe blades are manufactured from 30MNB5 boron steel and have a Rockwell hardness of 48-52 HRC. ATC hoe blades are manufactured using spherical moulds, this gives the blade a perfectly consistent curvature of the entire blade. This allows the blade, when engaged, to avoid wearing on the back side of the blade, and allows for even wearing of the blade.

ATC also supply tungsten carbide hardfaced blades coated with our unique tungsten grit matrix with trialled and tested placement of the tungsten hardfacing. ATC have conducted many trials with our customers and from these trials we know what works best offering the longest wear life.

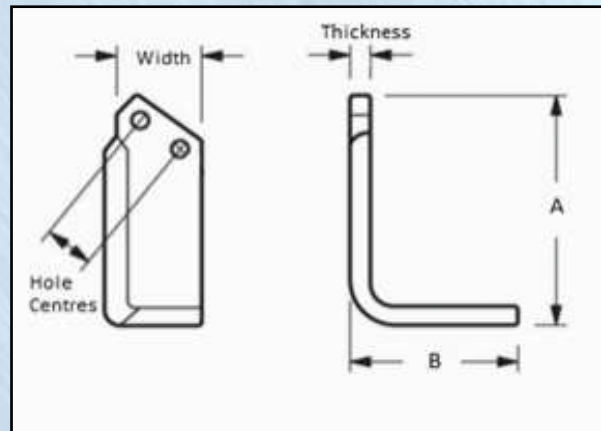

Brand	Size A	Size B	Hole Dia	Hole Centres	Width Thickness	ATC P/No	Price Ea Standard	Price Ea Hardfaced
<b>Agrator</b> L Power Blade	200mm	150mm	16.5mm	75mm	105mm x 8mm	A-RHHO52LH A-RHHO52RH		

Above suits AM & MRP Agrator models. OEM 8808701 / 8808702 - Bolt Kit F-RH78778 M16 x 45mm

<b>Breviglieri</b> L Power Blade	180mm	136mm	14.5mm	57mm	80mm x 8mm	A-RHCEL22LH A-RHCEL22RH		
-------------------------------------	-------	-------	--------	------	------------	----------------------------	--	--

Above suits Brevi B83, 103, 123, 170, 250 Doble & Maxi OEM 0064818D/S - Bolt Kit F-RH78777 M14 x 50mm

<b>Breviglieri</b> C Speed Blade	195mm	136mm	14.5mm	57mm	80mm x 8mm	A-RHCEL21LH A-RHCEL21RH		
-------------------------------------	-------	-------	--------	------	------------	----------------------------	--	--

Above suits Brevi B83, 103, 123, 170, 250 Doble & Maxi OEM 0064811D/S - Bolt Kit F-RH78777 M14 x 50mm

**Note on Breviglieri blade fitment options. You can also fit 1" longer blades for an increased working depth.**

Fit ATC Part no A-RHMA21LH/RH "C" blades or A-RHMA22LH/RH "L" blades.

On outer flanges fit shorter blades A-RHCEL21LH/RH "C" blades or A-RHCEL22LH/RH "L" blades.

<b>Celli</b> L Power Blade	180mm	136mm	14.5mm	57mm	80mm x 8mm	A-RHCEL22LH A-RHCEL22RH		
-------------------------------	-------	-------	--------	------	------------	----------------------------	--	--

Above suits Celli E, H, HV, F, G, K, Pioneer, Tiger, Ergon OEM 722533/722534 - Bolt Kit F-RH78790 M14 x 40mm

<b>Celli</b> C Speed Blade	195mm	136mm	14.5mm	57mm	80mm x 8mm	A-RHCEL21LH A-RHCEL21RH		
-------------------------------	-------	-------	--------	------	------------	----------------------------	--	--

Above suits Celli E, H, HV, F, G, K, Pioneer, Tiger, Ergon OEM 722537/722538 - Bolt Kit F-RH78790 M14 x 40mm

References to OEM brands and part numbers are for identification purposes only. Items are not sold as original equipment parts.

Email: paul@atcgroup.com.au Phone: 07 3285 7777 Mobile: 0448 588 433



Brand	Size A	Size B	Hole Dia	Hole Centres	Width Thickness	ATC P/No	Price Ea Standard	Price Ea Hardfaced
<b>CELLI</b> L Power Blade	180mm	136mm	14.5mm	50mm	70mm x 7mm	A-RHCEL14LH A-RHCEL14RH		
<b>Above suits Alpha, C, CE, models. OEM 331526 / 331527 - Bolt Kit F-RH78790 M14 x 40mm</b>								
<b>CELLI</b> C Speed Blade	195mm	136mm	14.5mm	50mm	70mm x 7mm	A-RHCEL10LH A-RHCEL10RH		
<b>Above suits Alpha, C, CE, models OEM 331528 / 331529 - Bolt Kit F-RH78790 M14 x 40mm</b>								
<b>CELLI</b> L Power Blade	207mm	140mm	16.5mm	57mm	90mm x 10mm	A-RHMA42LH A-RHMA42RH		
<b>Above suits Super Tiger OEM 722560 / 722561 - Bolt Kit F-RH78779 M16 x 50mm (Speed version also available)</b>								
<b>FALC</b> L Power Blade	180mm	136mm	14.5mm	57mm	80mm x 8mm	A-RHCEL22LH A-RHCEL22RH		
<b>Above suits Falc C, CS, E models OEM 762427 / 762428 - Bolt Kit F-RH78790 M14 x 40mm</b>								
<b>FALC</b> L Power Blade	200mm	150mm	16.5mm	75mm	105mm x 8mm	A-RHHO52LH A-RHHO52RH		
<b>Above suits Falc F, G, models OEM 762719 / 762720 also Gamma, Kappa models OEM 25.09.59/25.09.60</b>								
<b>FALC</b> L Power Blade	215mm	142mm	14.5mm	56mm	80mm x 8mm	A-RHMA22LH A-RHMA22RH		
<b>Above suits Falc D models OEM 79970 / 79971 - Bolt Kit F-RH78790 M14 x 40mm</b>								
<b>HOWARD</b> L Power Blade	180mm	138mm	16mm	51mm	80mm x 10mm	A-RHHO81LH A-RHHO81RH		
<b>Above suits R600, AH, CH, RC, HR40-43, AH,S,M, OEM 9862/9863 - Bolt Kit F-RH78776 5/8" x 1 3/4"</b>								
<b>HOWARD</b> C Speed Blade	210mm	138mm	16mm	51mm	80mm x 9mm	A-RHHO35LH A-RHHO35RH		
<b>Above suits R600, AH, CH, RC, HR40-43, AH,S,M, OEM 9950/9951 - Bolt Kit F-RH78776 5/8" x 1 3/4"</b>								
<b>HOWARD</b> Long Shank L	210mm	137mm	16mm	51mm	90mm x 8mm	A-RHHO46LH A-RHHO46RH		
<b>Above suits R600, AH, CH, RC, HR40-43, AH,S,M, OEM 9910/9911 - Bolt Kit F-RH78776 5/8" x 1 3/4"</b>								

All pricing is shown as exclusive of GST.



30 day trading account available to approved applicants. Contact Paul for an account application form. Email: paul@atcgroup.com.au

Brand	Size A	Size B	Hole Dia	Hole Centres	Width Thickness	ATC P/No	Price Ea Standard	Price Ea Hardfaced
<b>HOWARD</b> C Speed Blade	225mm	142mm	14.5mm	56mm	80mm x 8mm	A-RHMA21LH A-RHMA21RH		
<b>Above suits HR35-R2 Rotor models OEM 79972/79973 - Bolt Kit F-RH78790 M14 x 40mm</b>								
<b>HOWARD</b> L Power Blade	215mm	142mm	14.5mm	56mm	80mm x 8mm	A-RHMA22LH A-RHMA22RH		
<b>Above suits HR35-R2 Rotor OEM 79970/79971 - Bolt Kit F-RH78790 M14 x 40mm</b>								
<b>HOWARD</b> L Power Blade	175mm	140mm	13mm	57mm	80mm x 7mm	A-RHH001LH A-RHH001RH		
<b>Above suits R500, HR30, 35, 30A, E, AR, ST models OEM 3900 / 3901 - Bolt Kit F-RH78775 1/2" x 1 1/2"</b>								
<b>HOWARD</b> L Power Blade	200mm	150mm	16.5mm	75mm	105mm x 8mm	A-RHH052LH A-RHH052RH		
<b>Above suits HR50, 60, 61, "F Rotor" OEM 762719 / 762720 - Bolt Kit F-RH78779 M16 x 60mm</b>								
<b>KRONE</b> L Power Blade	200mm	150mm	16.5mm	75mm	105mm x 8mm	A-RHH052LH A-RHH052RH		
<b>Above suits Krone RF models OEM 1070830 / 1072690 - Bolt Kit F-RH78779 M16 x 60mm</b>								
<b>KUHN</b> L Power Blade	200mm	150mm	16.5mm	75mm	105mm x 8mm	A-RHH052LH A-RHH052RH		
<b>Above suits Kuhn 140N - EL 201, 282 models OEM 52359600 / 52359700 - Bolt Kit F-RH78779 M16 x 60mm</b>								
<b>KUHN</b> Cultitiller Tine	293mm long x 60mm wide x 15mm thick					A-RHTKU79LH A-RHTKU80RH		
<b>Above suits Kuhn EL201 - EL282 models OEM 52365700 / 52365800</b>								
<b>MASCHIO</b> L Power Blade	225mm	142mm	14.5mm	56mm	80mm x 8mm	A-RHMA22LH A-RHMA22RH		
<b>Above suits B, BI, C, SC, Teranova models OEM 0110428 / 0110429 - Bolt Kit F-RH78790 M14 x 40mm</b>								
<b>MASCHIO</b> C Speed Blade	215mm	142mm	14.5mm	56mm	80mm x 8mm	A-RHMA21LH A-RHMA21RH		
<b>Above suits B, BI, C, SC, Teranova OEM 0110426 / 0110427 - Bolt Kit F-RH78790 M14 x 40mm</b>								

ATC can supply sample tungsten carbide hardfaced blades for trial fitment. Contact Paul.  
Email: paul@atcgroup.com.au Phone: 07 3285 7777 Mobile: 0448 588 433





Brand	Size A	Size B	Hole Dia	Hole Centres	Width Thickness	ATC P/No	Price Ea Standard	Price Ea Hardfaced
<b>MASCHIO</b> C Speed Blade	257mm	142mm	16.5mm	68mm	90mm x 10mm	A-RHMA30LH A-RHMA30RH		
<b>Above suits G Series OEM 20100412 / 20100413 - Bolt Kit F-RH78779 M16 x 50mm</b>								
<b>MASCHIO</b> L Power Blade	244mm	142mm	16.5mm	68mm	90mm x 10mm	A-RHMA31LH A-RHMA31RH		
<b>Above suits G Series OEM 20100414 / 20100415 - Bolt Kit F-RH78779 M16 x 50mm</b>								
<b>MASCHIO</b> L Power Blade	213mm	145mm	16.5mm	56mm	90mm x 10mm	A-RHMA42LH A-RHMA42RH		
<b>Above suits S series Pantera OEM 09400418 / 09400419 - Bolt Kit F-RH78779 M16 x 50mm</b>								
<b>MASCHIO</b> C Speed Blade	214mm	145mm	16.5mm	56mm	90mm x 10mm	A-RHMA41LH A-RHMA41RH		
<b>Above suits S series Pantera OEM 09400414 / 09400415 - Bolt Kit F-RH78779 M16 x 50mm</b>								
<b>MASSANO</b> L Power Blade	180mm	136mm	14.5mm	57mm	80mm x 8mm	A-RHCEL22LH A-RHCEL22RH		
<b>Above suits Massano various - Bolt Kit F-RH78790 M14 x 40mm</b>								
<b>MASSANO</b> C Speed Blade	195mm	136mm	14.5mm	57mm	80mm x 8mm	A-RHCEL21LH A-RHCEL21RH		
<b>Above suits Massano various - Bolt Kit F-RH78790 M14 x 40mm</b>								
<b>SICMA</b> L Power Blade	180mm	136mm	14.5mm	57mm	80mm x 8mm	A-RHCEL22LH A-RHCEL22RH		
<b>Above suits RG, SP Series OEM 4814002 / 4814003 - Bolt Kit F-RH78790 M14 x 40mm</b>								
<b>SICMA</b> C Speed Blade	195mm	136mm	14.5mm	57mm	80mm x 8mm	A-RHCEL21LH A-RHCEL21RH		
<b>Above suits RG, SP Series OEM 4814004 / 4814005 - Bolt Kit F-RH78790 M14 x 40mm</b>								
<b>SICMA</b> Antipan Blade	60mm wide x 12mm thick. 3 x 14.5mm holes 2 holes on 50mm centres.					A-RHSI48LH A-RHSI48RH		
<b>Above suits RP, RH, RG models OEM 4814514 / 4814515 - Bolt Kit M14 x 45mm</b>								



ATC also provide a custom tungsten carbide hardfacing service. With over 20 years experience and robotic and computer aided delivery systems, we are very skilled at what we do. Contact us to discuss your requirements.

Brand	Size A	Size B	Hole Dia	Hole Centres	Width Thickness	ATC P/No	Price Ea Standard	Price Ea Hardfaced
<b>TORTELLA</b> C Speed Blade	195mm	136mm	14.5mm	57mm	80mm x 8mm	A-RHCEL21LH A-RHCEL21RH		
<b>Above suits T3-T4 OEM 2985204 / 2985206 - Bolt Kit F-RH78790 M14 x 40mm</b>								
<b>TORTELLA</b> L Power Blade	180mm	136mm	14.5mm	57mm	80mm x 8mm	A-RHCEL22LH A-RHCEL22RH		
<b>Above suits T3-T4 OEM 2985214 / 2985216 - Bolt Kit F-RH78790 M14 x 40mm</b>								
<b>WECAN</b> L Power Blade	180mm	136mm	14.5mm	57mm	80mm x 8mm	A-RHCEL22LH A-RHCEL22RH		
<b>Above suits DGW, MGW series OEM Celli205 - Bolt Kit F-RH78790 M14 x 40mm</b>								
<b>WECAN</b> C Speed Blade	195mm	136mm	14.5mm	57mm	80mm x 8mm	A-RHCEL21LH A-RHCEL21RH		
<b>Above suits DGW, MGW models LG80HP - Bolt Kit F-RH78790 M14 x 40mm</b>								
<b>VALENTINI</b> L Power Blade	213mm	145mm	16.5mm	56mm	90mm x 10mm	A-RHMA42LH A-RHMA42RH		
<b>Above suits ER Hercules 4.2m - 7.7m - Bolt Kit F-RH78779 M16 x 60mm</b>								
<b>VALENTINI</b> C Speed Blade	214mm	145mm	16.5mm	56mm	90mm x 10mm	A-RHMA41LH A-RHMA41RH		
<b>Above suits ER Hercules 4.2m to 7.7m - Bolt Kit F-RH78779 M16 x 60mm</b>								

**New! Kuhn Cultitiller blades.**  
OEM 52365700 / 52365800.



**New! Sicma Antipan blades. OEM 4814515 / 4814514.**  
ATC Part No A-RHSI48LH / A-RHSI48RH



Actual results from an Australian producer with over 1,000 hectares under cultivation. Monitored hour and hectare trial using a Kuhn EL 282 rotary hoe, 260Hp tractor, 350 rpm hoe blade speed, travel speed 2.2km per hour. Soil type, red loamy soil. Result - ATC hardfaced boron blades lasted 3.4 times longer compared to a non hardfaced boron blade. ATC Group delivered a 51% decrease of cost per blade to the customer. Additional cost savings of time and labour for the change out of worn blades - 2 change outs of blades were not required. *“Very impressed”*

References to OEM brands and part numbers are for identification purposes only. Items are not sold as original equipment parts.

Email: paul@atcgroup.com.au Phone: 07 3285 7777 Mobile: 0448 588 433



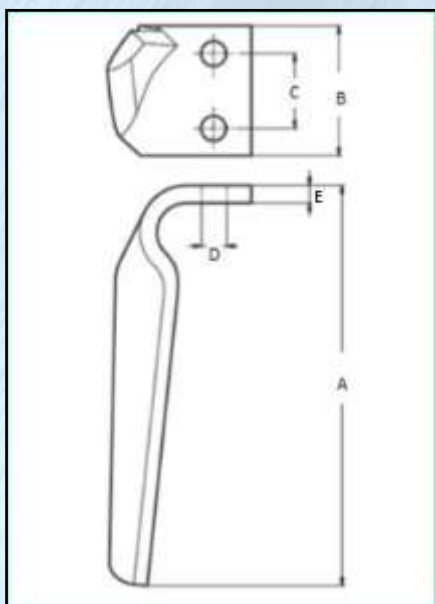

ATC power harrow blades are manufactured from 30MNB5 Italian boron steel and have a Rockwell hardness of 48-52 HRC to provide the very best performance in wear resistance. ATC GROUP only supply bolt on applications and do not stock quick fit blades due to patents.

ATC GROUP has always been driven to be the absolute leader in the field of hard facing and tungsten carbide overlay. To achieve this we constantly evolve our process, experimenting with application technology, matrix selection, alloys and pre/post heat treatment regimes.

ATC's tungsten carbide hardfaced power harrow blades greatly extend wear life and saves time and labour cost by not having to change out worn blades anywhere near as often. ATC can also hardface blade holders so you will never need to replace.

Brand	Size A	Size B	Hole Dia	Hole Centres	Thickness	ATC P/No	Price Ea Standard	Price Ea Hardfaced
CELLI	280mm	90mm	17mm	50mm	12mm	A-PHMA16RH A-PHMA16LH		
Above suits ER, ER/P Ranger, Ranger/P OEM 622715/622716 - Bolt Kit F-RH78779 M16 x 60mm								
FALC	280mm	90mm	16.5mm	50mm	14mm	A-PHMA31RH A-PHMA31LH		
Above suits Fox OEM 512075 / 512076 - Bolt Kit F-RH78779 M16 x 60mm								
KVERNELAND	280mm	90mm	17mm	50mm	12mm	A-PHMA16RH A-PHMA16LH		
Above suits PH, PB, NG models OEM 010146 / 020146 - Bolt Kit F-RH78779								
SICMA	280mm	90mm	17mm	50mm	12mm	A-PHMA16RH A-PHMA16LH		
Above suits Super 300 OEM 052701 / 052801 - Bolt Kit F-RH78779 M16 x 60mm								
MASCHIO	280mm	90mm	16.5mm	50mm	14mm	A-PHMA31RH A-PHMA31LH		
Above suits DC,DS,DL, Falco, Gabbiano OEM 38100222 / 3 - Bolt Kit F-RH78779 M16 x 60mm								
MASCHIO	300mm	100mm	16.5mm	60mm	15mm	A-PHMA36RH A-PHMA36LH		
Above suits DM, Aquila OEM 36100215 / 36100216 - Bolt Kit F-RH78779 M16 x 60mm								



All pricing is shown as exclusive of GST.

30 day trading account available to approved applicants. Contact Paul for an account application form. Email: paul@atcgroup.com.au

**Now Available!**

**Lely Roterra / Tulip power harrow club tines.**

Replaces OEM LH 1.1699.0111.0  
RH 1.1699.0112.0

ATC Part No A-PHLEL16LH  
ATC Part No A-PHLEL16RH



**Now Available!**

**Kuhn Cultitiller Blades LH/RH**

Kuhn Cultitiller blade LH OEM 52359200  
Kuhn Cultitiller blade RH OEM 52359300



ATC Part No A-RHTKUK92L  
ATC Part No A-RHTKUK93R

**NOTES**

MACHINE TYPE	MAKE / MODEL	ATC PART NO	PRICE EA	QUANTITY REQ'D

Email: paul@atcgroup.com.au Phone: 07 3285 7777 Mobile: 0448 588 433

WEB: www.atcgroup.com.au





## Ground Engaging Wearparts

**Ripper assemblies, points,  
shin guards, shear pins,  
aerator tines.**

Our quality cast wearparts are made from high quality nickel Chromalloy steel. The steel we use is a high nickel steel not relying heavily on high carbon levels to achieve hardness. Many companies use high carbon steel instead of nickel to reduce production costs at the expense of ductility and durability. ATC never compromise quality to reduce costs.

ATC tungsten carbide hardfacing on shanks, shin guards and points will greatly extend wear life in the harshest conditions.



**Phone: 07 3285 7777 or Mobile 0448 588 433**

**Email: [sales@atcgroup.com.au](mailto:sales@atcgroup.com.au) WEB [www.atcgroup.com.au](http://www.atcgroup.com.au)**

ATC ripper leg assemblies suit 4" x 4" square RHS toolbars. They are supplied as a complete assembly including, point, shin guard, all fasteners and shear pin rated with a 5T breakout. All spare parts are readily available. Assemblies can be purchased with pre fitted tungsten carbide hardfaced points and shin guards and hardfaced shank or as standard assemblies.

ATC Part No	Description	Price Ea
A-RI024A	24" ripper leg assembly complete	
A-RI024A-WC	24" ripper leg assembly complete with hardfaced point, shin guard.	
A-RI024A-WC2	24" ripper leg assembly complete with hardfaced point, shin guard and shank.	
A-RI030A	30" ripper leg assembly complete	
A-RI030A-WC	30" ripper leg assembly complete with hardfaced point, shin guard.	
A-RI030A-WC2	30" ripper leg assembly complete with hardfaced point, shin guard and shank.	
A-RISHANK24	24" ripper leg only	
A-RISHANK24-WC	24" ripper leg only with hardfacing	
A-RISHANK30	30" ripper leg only	
A-RISHANK30-WC	30" ripper leg only with hardfacing	
A-121-1031	Shin guard	
A-121-1031-WC	Shin guard with hardfacing	
A-RIPOINT	Ripper point	
A-RIPOINT-WC	Ripper point with hardfacing	
A-122-2001-WC	Agrowplow style ripper point with hardfacing	
F-SP	Shear pin	
F-CC	Clevis clips	
A-ACP003-SG	Shin guard to suit Gessner	
Gessner shin guards available as a hardfaced part as well.		



All pricing is shown as exclusive of GST. Items are not sold as original equipment parts.

Email: paul@atcgroup.com.au Phone: 07 3285 7777 Mobile: 0448 588 433



### Ripper Leg Mulch Blades

ATC Part No	Description	Price Ea
A-RIMB-K	Mulch Blade Kit	
A-RIMBA-LH	Adapter LH with fasteners	
A-RIMBA-RH	Adapter RH with fasteners	
A-RIMB	Mulch Blade	

The Mulch blade kit includes 1 x LH and 1 X RH adapter with fasteners and 2 x Mulch blades.



### Ripper Points

ATC Part No	Description	Price Ea
A-ACP003-WC	Gessner style hardfaced point OEM Ref 7004-026	
A-ACP010-WC	Yeoman style hardfaced point WB-3 wombat	



A-ACP003-WC



A-ACP010-WC

### Aerator Tines

ATC Part No	Description	Shattertine style		Price Ea
A-ST5455-LH	Shattertine style LH			
A-ST5455-LH-WC	Shattertine style LH hardfaced			
A-ST5455-LH	Shattertine style LH			
A-ST5455-LH-WC	Shattertine style LH hardfaced			

To fit Aerway, Berends Growmaster, Agrifarm Agrivator, Farmtech and Leda aerators.



Email: paul@atcgroup.com.au Phone: 07 3285 7777 Mobile: 0448 588 433

WEB: www.atcgroup.com.au







## Ground Engaging Wearparts



**Scalloped Discs**



**Labrador Discs**



**Plain Disc**

ATC Group supply a complete range of GWT and Agpoint discs and coulters.

Manufactured with a unique boron steel alloy that delivers a Rockwell hardness up to 52 RC without causing brittleness or loss of elasticity.

Compared to high carbon steel, there's just no comparison.

**Coulters available in plain, wavy, fluted and radial styles.**



**Phone: 07 3285 7777 or Mobile 0448 588 433**

**Email: [sales@atcgroup.com.au](mailto:sales@atcgroup.com.au) WEB [www.atcgroup.com.au](http://www.atcgroup.com.au)**

### Machine make abbreviation reference chart.

ALFM	Alfarm	EZ	Ezee-On	JA	Jarrett
BNL	Bonel	GZY	Grizzly / K-Line	JD	John Deere
BH	Bush Hog	GR	Gibbons Rawling	MF	Massy Ferguson
CH	Chamberlain	GN	Gessner	NG	Napier Grasslands
CSN	Connor Shea Napier	HGE	Hodge	CH	Shearer
CS	Connor Shea	HB	Horwood Bagshaw	STG	Steiger
CW	Country Wide	HT	Holden HT	TW	Taylorway
DB	David Brown	HU	Hutchmaster	WY	Wyper
EN	Ennor Eng	IH	Inter-Harvester	Y	Yeoman

#### Abbreviations

PCR = Pitch Circle Radius. To determine PCR measure from centre of centre hole to centre of radial hole

PCD = Pitch Circle Diameter. This measurement is simply the PCR x 2

RCH = Round centre hole

SCH = Square centre hole

F/B = Flat back

SN = Small notch

## Tungsten carbide hardfaced disc available from ATC Group!

ATC can supply discs in any size with tungsten carbide overlay to greatly extend the life of plough discs. For more information please contact Paul on email or phone as listed below.



Email: [paul@atcgroup.com.au](mailto:paul@atcgroup.com.au) Phone: 07 3285 7777 Mobile: 0448 588 433

WEB: [www.atcgroup.com.au](http://www.atcgroup.com.au)



ATC Part Number	Thick mm	Type	Dish mm	Centre Hole RND=Round SQ=Square NCH=No Hole FB=Flat Back	Radial Holes	PCR Pitch circle radius.	Applications	KG	Price Ea
<b>13" Diameter—Plain / Scalloped</b>									
A-DI04150	3mm	Plain	24mm	NCH	5 x 7.1 mm	47.6mm	CS, SH, SNH SUGAR CANE PLANTER	2.3	
A-DI04150S	3mm	SC	24mm	NCH	5 x 7.1 mm	47.6mm	CS, SH, SNH SUGAR CANE PLANTER	2.3	
A-DI04252	3mm	Plain	24mm	46mm RND	7 x 7 mm	50.8mm	SHEARER DISC DRILL	2.3	
<b>16" Diameter—Plain Scalloped</b>									
A-DI02C	4mm	Plain	38mm	27mm & 30mm SQ			JARRETT, HORWOOD BAGSHAW, MASSEY FERGUSON	4	
A-DI04C	4mm	SC	38mm	27mm & 30mm SQ			JARRETT, HORWOOD BAGSHAW, MASSEY FERGUSON	3.8	
<b>18" Diameter—Scalloped</b>									
A-DI011	4mm	SC	41mm	NCH / FB	4 x 12mm	60mm	AMAZONE CATROS, 20 NOTCH SERIES 3	4.7	
A-DI06C	5mm	SC	53mm	27mm & 30mm SQ			DB103, MASSEY FURGUSON, CONNER SHEA NAPIER, JARRETT, BONEL	6.5	
<b>20" Diameter—Plain</b>									
A-DI011C	4mm	Plain	67mm	27mm & 30mm SQ			JARRETT, BONEL, CONNOR SHEA NA- PIER, HORWOOD BAGSHAW, DANIEL HARVEY, SHEARER, MASSEY FURGUSON	6.1	
A-DI021C	4mm	Plain	51mm	39mm & 41mm SQ			CONNOR SHEA NAPIER 670, HODGE, BONEL	6.1	
A-DI017C	5m	Plain	51mm	30mm & 33mm SQ			IH, GL90, SHEARER, CONNOR SHEA NAPIER	7.2	
<b>20" Diameter—Labrador "Fluted"</b>									
A-DI012CLA	4mm	Fluted	51mm	27mm & 30mm SQ			JARRETT, BONEL, CONNOR SHEA NA- PIER, SHEARER, MASSEY FURGUSON	6.1	
<b>20" Diameter—Scalloped</b>									
A-DI012C	4mm	SC	67mm	27mm & 30mm SQ			JARRETT, BONEL, CONNOR SHEA NA- PIER, SHEARER, MASSEY FURGUSON	5.8	
A-DI013C	4mm	SC	51mm	27mm & 30mm SQ FB			JARRETT, BONEL, CONNOR SHEA NA- PIER, SHEARER, MASSEY FURGUSON	5.8	
A-DI018C	5mm	SC	51mm	27mm & 30mm SQ			JARRETT, BONEL, CONNOR SHEA NA- PIER, SHEARER, MASSEY FURGUSON	7.6	

All pricing is shown as exclusive of GST. Items are not sold as original equipment parts.

Email: paul@atcgroup.com.au Phone: 07 3285 7777 Mobile: 0448 588 433



ATC Part Number	Thick mm	Type	Dish mm	Centre Hole RND=Round SQ=Square NCH=No Hole FB=Flat Back	Radial Holes	PCR Pitch circle radius.	Applications	KG	Price Ea
<b>20" Diameter—Scalloped continued</b>									
A-DI020025	5mm	SC	51mm	62mm RND Dual Elongated FB	5 x 14mm	55.8mm	LELY TULIP—TRI RUBBERS / MULTIDISC	7.6	
A-2061SFB	6mm	SC	52mm	NCH	5 x 13mm	53mm	HORSCH JOKER	9.75	
<b>22" Diameter—Plain</b>									
A-DI021C	5mm	Plain	70mm	39mm & 41mm SQ			SHEARER, HORWOOD BAGSHAW, FORWARD	9.7	
A-DI024C	5mm	Plain	70mm	27mm & 30mm SQ			SHEARER, INTERNATIONAL HARVESTER	9.5	
A-DI025C	5mm	Plain	60mm	30mm & 33mm SQ			MASSEY FERGUSON, CHAMBERLAIN	9.5	
A-DI022026	5mm	Plain	60mm	70mm RND	6 x 18mm	56.4mm	CONNOR SHEA, BABY GIANT, DOD	9.8	
<b>22" Diameter—Labrador "Fluted"</b>									
A-DI041CLA	5mm	Fluted	55mm	30mm SQ			CONNOR SHEA NAPIER, SHEARER, HORWOOD BAGSHAW	9.8	
A-DI060CLA	5mm	Fluted	51mm	NCH	6 x 13.5mm	50mm	BEDNAR SWIFTER,	9.8	
A-DI044CLA	6mm	Fluted	55mm	70mm RND	4 x 18.3mm	68.5mm	GRIZZLY GRUMPY, KLINE	10.8	
<b>22" Diameter—Scalloped</b>									
A-DI022160	4mm	SC	85mm	27mm & 30mm SQ			JARRETT	7	
A-DI022028	5mm	SC	60mm	62mm RND Dual Elongated FB	5 x 14mm	55.8mm	LELY TULIP—TRI RUBBERS / MULTIDISC	9	
A-DI040C	5mm	SC	60mm	39mm & 41mm SQ			JARRETT, WYPERFIELD, BONEL, CON- NOR SHEA, NAPIER, TAYLORWAY	9	
A-DI041C	5mm	SC	60mm	30mm SQ			CONNOR SHEA NAPIER, SHEARER, HORWOOD BAGSHAW	9	
A-DI042C	5mm	SC	68mm	27mm & 30mm SQ FB			INTERNATIONAL HARVESTER 3-4, MASSEY FURGUSON, CHAMBERLAIN	9	
A-DI043	5mm	SC	60mm	70mm RND	6 x 18.3mm	56.5mm	CONNOR SHEA, BABY GIANT , DOD	9	

ATC also provide a custom tungsten carbide hardfacing service. With over 20 years experience and robotic and computer aided delivery systems, we are very skilled at what we do. Contact us to discuss your requirements.



ATC Part Number	Thick mm	Type	Dish mm	Centre Hole RND=Round SQ=Square NCH=No Hole FB=Flat Back	Radial Holes CSK=Counter sunk SQ=Square	PCR Pitch circle radius.	Applications	KG	Price Ea
<b>22" Diameter—Scalloped continued</b>									
A-DI050C	6mm	SC	68mm	27mm & 30mm SQ FB			INTERNATIONAL HARVESTER, MASSEY FERGUSON	10.6	
A-DI051	6mm	SC	70mm	70mm RND	6 x 17.5mm	56.4mm	CONNOR SHEA, BABY GIANT , DOD	10.6	
A-DI052C	6mm	SC	60mm	30mm SQ			CONNOR SHEA NAPIER, SHEARER	10.6	
A-DI053C	6mm	SC	70mm	41.5mm SQ			JARRETT, WYPERFIELD, BONEL, CONNOR SHEA NAPIER	10.6	
A-DI055	6mm	SC	70mm	70mm RND	4 x 18mm	68.5mm	GRIZZLY GRUMPY, KLINE	10.6	
<b>23" Scalloped</b>									
A-2351SFB	5mm	SC	53mm	NCH	4 x 13mm	55mm	POTTINGER TERRA	9.7	
<b>24" Plain</b>									
A-DI080	5mm	Plain	89mm	27mm RND	6 x 12.7mm CSK	82.6mm	SHEARER 5GP	11.1	
A-DI081	5mm	Plain	80mm	26mm RND	4 x 13.5mm SQ	90.5mm	INTERNATIONAL HARVESTER 1-6	11.1	
A-DI082C	5mm	Plain	80mm	30mm SQ			SHEARER, CONNOR SHEA NAPIER, INTERNATIONAL HARVESTER, HORWOOD BAGSHAW	11.1	
A-DI083	5mm	Plain	80mm	25mm RND	4 x 11.9mm SQ CSK	82.6mm	MASSEY FERGUSON 67, 63, 63-5	11.1	
A-DI084	5mm	Plain	98mm	33mm SQ			CHAMBERLAIN	11.1	
A-DI085C	5mm	Plain	75mm	40mm SQ			SHEARER, HORWOOD BAGSHAW, INTERNATIONAL HARVESTER, BUSH HOG, CONNOR SHEA NAPIER, JARRETT	11.1	
A-DI086	5mm	Plain	80mm	25mm RND	3 x 17mm SQ	92mm	CONNOR SHEA SERIES 4 ONE WAY	11.1	
A-DI088	5mm	Plain	80mm	DOME FB	6 x 13.5mm SQ	102mm	CONNOR SHEA SERIES 1,2,3 ONE WAY	11.1	
A-DI091C	6mm	Plain	75mm	30mm & 33mm SQ			SHEARER, CONNOR SHEA NAPIER, JOHN DEERE, BONEL	14.7	

References to OEM brands and part numbers are for identification purposes only. Items are not sold as original equipment parts.

Email: paul@atcgroup.com.au Phone: 07 3285 7777 Mobile: 0448 588 433



ATC Part Number	Thick mm	Type	Dish mm	Centre Hole RND=Round SQ=Square NCH=No Hole FB=Flat Back	Radial Holes CSK=Counter sunk SQ=Square	PCR Pitch circle radius.	Applications	KG	Price Ea
<b>24" Plain continued</b>									
A-2462FB	6mm	Plain	67mm	NCH Flat	4 x 13.5mm	66.5mm	DEGELMAN	14.6	
<b>24" Labrador "Fluted"</b>									
A-DI099CLA	6mm	Fluted	75mm	70mm RND	4 x 18.3mm	68.5mm	GRIZZLY GRUMP, KLINE	14.6	
A-DI0100CLA	6mm	Fluted	75mm	30mm SQ			CONNOR SHEA NAPIER, SHEARER, BONEL	14.6	
A-DI0101CLA	6mm	Fluted	75mm	40mm & 42mm SQ			INTERNATIONAL HARVESTER, SHEARER, CONNOR SHEA NAPIER, GIBBONS RAWLINGS,, JARRETT, BONEL	13.9	
A-DI0102CLA	6mm	Fluted	80mm	54mm & 60mm			INTERNATIONAL HARVESTER 3-5	13.9	
A-DI0103CLA	6mm	Fluted	70mm	70mm RND	6 x 18.3mm	56.5mm	CONNER SHEA, BABY GIANT, DOD	13.9	
A-DI0106CLA	6mm	Fluted	70mm	46mm RND			MILLER, DELMADE, SHEARER, BALDAN	13.9	
A-DI0107CLA	6mm	Fluted	70mm	100mm RND	6 X 22mm	92.5mm	GRIZZLY S SERIES	13.9	
A-DI0109CLA	6mm	Fluted	70mm	39mm SQ FB			INTERNATIONAL HARVESTER 596	13.9	
<b>24" Scalloped</b>									
A-DI072C	5mm	SC	70mm	30mm SQ			SHEARER, CONNOR SHEA NAPIER	10.8	
A-DI074C	6mm	SC	70mm	30mm SQ			SHEARER, CONNOR SHEA NAPIER	13.6	
A-DI092C	5mm	SC	84mm	30mm SQ			SHEARER, CONNOR SHEA NAPIER, INTERNATIONAL HARVESTER	10.8	
A-DI093	5mm	SC	84mm	70mm RND	6 x 17.5mm	56.4mm	CONNER SHEA, BABY GIANT, DOD	10.8	
A-DI094C	5mm	SC	68mm	39mm & 41mm SQ			SHEARER, HORWOOD BAGSHAW, INTERNATIONAL HARVESTER, CONNOR SHEA NAPIER, JARRETT, TAYORWAY	10.8	
A-DI099	6mm	SC	75mm	70mm RND	4 x 18.3mm	68.5mm	GRIZZLY GRUMP, KLINE SPEED TILLER	13.6	
A-DI0100C	6mm	SC	75mm	30mm SQ			SHEARER, CONNOR SHEA NAPIER, BONEL	13.6	

ATC Part Number	Thick mm	Type	Dish mm	Centre Hole RND=Round SQ=Square NCH=No Hole FB=Flat Back	Radial Holes CSK=Counter sunk SQ=Square	PCR Pitch circle radius.	Applications	KG	Price Ea
<b>24" Scalloped continued</b>									
A-DI0101C	6mm	SC	70mm	39mm & 41mm SQ			SHEARER, CONNOR SHEA NAPIER, BONEL, JARRETT, GIBBONS RAWLINGS, INTERNATIONAL HARVESTER	13.6	
A-DI0102	6mm	SC	70mm	54mm & 60mm SQ			INTERNATIONAL HARVESTER 3-5	13.6	
A-DI0103	6mm	SC	80mm	70mm RND	6 x 18.3mm	56.5mm	CONNER SHEA, BABY GIANT, DOD	13.6	
A-DI0104	6mm	SC	80mm	70mm RND	6 x 22mm	95mm	CONNER SHEA, LITTLE GIANT, BONEL, ENNOR	13.6	
A-DI0105C	6mm	SC	80mm	39mm & 41mm SQ			CONNOR SHEA NAPIER, JARRETT, TAYORWAY	13.6	
A-DI0106	6mm	SC	80mm	46mm RND			MILLER, DELMADE, SHEARER, BALDAN, SUNFLOWER	13.6	
A-2461SFB	6mm	SC	66mm	NCH Flat	6 x 13mm	62.5mm	HORSCH JOKER	13.6	
A-248SFB	6mm	SC	61mm	NCH Flat	5 X 14mm	56.5mm	SIMBA	13.6	
A-DI0107	6mm	SC	80mm	100mm RND	6 x 22mm	92.5mm	GRIZZLY S SERIES	13.6	
A-DI0109	6mm	SC	70mm	39mm SQ FB			INTERNATIONAL HARVESTER 596	13.6	
A-DI0112	6mm	SC	80mm	33mm SQ & 39mm RND			UNABEAM, JOHN DEERE 331	13.6	
A-2462SFB	6mm	SC	67mm	NCH Flat	4 X 13.5mm	66.5mm	DEGELMAN	13.6	
<b>26" Plain</b>									
A-DI0117	5mm	Plain	100mm	28.6mm RND	5 x 12mm SQ CSK	104.77mm	MASSEY FURGUSON	14.6	
A-DI0118	5mm	Plain	100mm	32mm SQ	4 x 13.5mm SQ CSK	115mm	CONNOR SHEA NAPIER 570, INTERNATIONAL HARVESTER, BONEL	14.6	
A-DI0119	5mm	Plain	100mm	33mm SQ			CHAMBERLAIN	14.6	
A-DI0121C	5mm	Plain	100mm	39mm & 41mm SQ			INTERNATIONAL HARVESTER, SHEARER, JARRETT, CONNOR SHEA NAPIER 570, GIBBONS RAWLINGS, SOVEREIGN	14.6	

All pricing is shown as exclusive of GST. Items are not sold as original equipment parts.

Email: paul@atcgroup.com.au Phone: 07 3285 7777 Mobile: 0448 588 433



ATC Part Number	Thick mm	Type	Dish mm	Centre Hole RND=Round SQ=Square NCH=No Hole FB=Flat Back	Radial Holes CSK=Counter sunk SQ=Square	PCR Pitch circle radius.	Applications	KG	Price Ea
<b>26" Plain continued</b>									
A-DI0122	5mm	Plain	100mm	21mm RND	6 x 13mm CSK	82.5mm	SHEARER 5GP	14.6	
A-DI0123	5mm	Plain	100mm	25mm RND	3 X 17mm SQ	92mm	CONNOR SHEA SERIES 4	14.6	
A-DI0124C	6mm	Plain	88mm	30mm & 33mm SQ			BONEL, CONNOR SHE NAPIER, CHAMBERLAIN, TAYLORWAY	16.2	
A-DI0125	6mm	Plain	88mm	78mm RND	6 x 22mm	95mm	CONNOR SHEA, LITTLE GIANT, BONEL, ENNOR	16.2	
A-DI0126C	6mm	Plain	100mm	39mm & 41mm SQ			COONOR SHEA 563, 604, JARRETT, TAYLORWAY	16.2	
A-DI0164	6mm	Plain	100mm	21mm RND	6 x 13mm CSK	82.5mm	SHEARER 5GP	16.2	
<b>26" Labrador—Fluted</b>									
A-DIO137CLA	6mm	Fluted	90mm	70mm RND	4 x 18.3mm	68.5mm	GRIZZLY GRUMPY	15.6	
A-DIO139CLA	6mm	Fluted	90mm	100mm RND	6 x 22mm	92.5mm	GRIZZLY S SERIES, BELMAC	15.6	
A-DIO140CLA	6mm	Fluted	90mm	78mm RND	6 x 22mm	95mm	CONNOR SHEA, LITTLE GIANT, BONEL, ENNOR	15.6	
A-DIO141CLA	6mm	Fluted	90mm	39mm & 41mm SQ			JARRETT, GIBBONS RAWLINGS, SHEAR- ER, BONEL, CONNOR SHEA NAPIER 670 & 730	15.6	
A-DIO143CLA	6mm	Fluted	90mm	54mm & 60mm SQ			INTERNATIONAL HARVESTER 3-5, SHEARER 700	15.6	
A-DIO144CLA	6mm	Fluted	90mm	70mm RND	6x 18.3mm	56.5mm	CONNOR SHEA, BABY GIANT & DOD	15.6	
A-DIO146CLA	6mm	Fluted	90mm	46mm RND			MILLER, DELMADE, SHEARER, BALDAN	15.6	
A-DIO160CLA	6mm	Fluted	90mm	30mm & 33mm SQ			JOHN DEERE, ENNOR	15.6	
A-DIO161CLA	6mm	Fluted	90mm	39mm SQ FB			INTERNATIONAL HARVESTER 596, 770	15.6	
A-2064WFB	6mm	Fluted	90mm	NCH Flat	4 x 13.5mm	66.5mm	DEGELMAN	15.6	
A-DIO150CLA	8mm	Fluted	90mm	54mm & 60mm SQ			INTERNATIONAL HARVESTER 3-5, SHEARER 700	20.8	

References to OEM brands and part numbers are for identification purposes only. Items are not sold as original equipment parts.

Email: paul@atcgroup.com.au Phone: 07 3285 7777 Mobile: 0448 588 433





ATC Part Number	Thick mm	Type	Dish mm	Centre Hole RND=Round SQ=Square NCH=No Hole FB=Flat Back	Radial Holes CSK=Counter sunk SQ=Square	PCR Pitch circle radius.	Applications	KG	Price Ea
<b>26" Labrador—Fluted continued</b>									
A-DI0151CLA	8mm	Fluted	90mm	100mm RND	6 x 22mm	92.5mm	GRIZZLY S SERIES, BELMAC	20.8	
A-DI0152CLA	8mm	Fluted	90mm	52mm RND			EZEE-ON, STEIGER, COUNTRYWIDE	20.8	
A-DI0153CLA	8mm	Fluted	90mm	78mm RND	6 x 22mm	95mm	BONEL, CONNOR SHEA, LITTLE GIANT, ENNOR	20.8	
A-DI0154CLA	8mm	Fluted	90mm	39mm & 41mm SQ			CONNOR SHEA NAPIER, JARRETT, GIBBONS RAWLINGS	20.8	
A-DI0155CLA	8mm	Fluted	90mm	58mm RND			KELLOW	20.8	
A-DI0162CLA	8mm	Fluted	90mm	39mm SQ FB			INTERNATIONAL HARVESTER 596, 770	20.8	
A-DI0163CLA	8mm	Fluted	90mm	46mm RND			MILLER, DELMADE, SHEARER, BALDAN	20.8	
A-DI0167LA	8mm	Fluted	90mm	43mm RND			TATU OFFSET	20.8	
<b>26" Scalloped</b>									
A-DI0137	6mm	SC	88mm	70mm RND	4 x 18.3mm	68.5mm	GRIZZLY GRUMPY	15	
A-DI0139	6mm	SC	88mm	100mm RND	6 x 22mm	92.5mm	GRIZZLY S SERIES, BELMAC	15	
A-DI0140	6mm	SC	88mm	78mm RND	6 x 22mm	95mm	CONNOR SHEA, LITTLE GIANT, BONEL, ENNOR	15	
A-DI0141C	6mm	SC	88mm	39mm & 41mm SQ			JARRETT, GIBBONS RAWLINGS, SHEARER, BONEL, CONNOR SHEA NAPIER 670 & 730	15	
A-DI0142C	6mm	SC	70mm	39mm & 41mm SQ			JARRETT, TAYLORWAY	15	
A-DI0143C	6mm	SC	88mm	54mm & 60mm SQ			INTERNATIONAL HARVESTER 3-5, SHEARER 700	15	
A-DI0144	6mm	SC	88mm	70mm RND	6x 18.3mm	56.5mm	CONNOR SHEA, BABY GIANT & DOD	15	
A-DI0146	6mm	SC	88mm	46mm RND			MILLER, DELMADE, SHEARER, BALDAN	15	
A-DI0147	6mm	SC	100mm	39mm & 41mm SQ			KUHN DISCOVER XS, XM, XL	15	

ATC Part Number	Thick mm	Type	Dish mm	Centre Hole RND=Round SQ=Square NCH=No Hole FB=Flat Back	Radial Holes CSK=Counter sunk SQ=Square	PCR Pitch circle radius.	Applications	KG	Price Ea
<b>26" Scalloped continued</b>									
A-DI0160C	6mm	SC	100mm	30mm & 33mm SQ			JOHN DEERE, ENNOR	15.6	
A-DI0161	6mm	SC	81mm	39mm SQ FB			INTERNATIONAL HARVESTER 596, 770	15.6	
A-DI0150C	8mm	SC	88mm	54mm & 60mm SQ			INTERNATIONAL HARVESTER 3-5, SHEARER 700	20.8	
A-DI0151	8mm	SC	88mm	100mm RND	6 x 22mm	92.5mm	GRIZZLY S SERIES, BELMAC	20.8	
A-DI0152	8mm	SC	88mm	52mm RND			EZEE-ON, STEIGER, COUNTRYWIDE	20.8	
A-DI0153	8mm	SC	88mm	78mm RND	6 x 22mm	95mm	BONEL, CONNOR SHEA, LITTLE GIANT, ENNOR	20.8	
A-DI0154C	8mm	SC	88mm	39mm & 41mm SQ			CONNOR SHEA NAPIER, JARRETT, GIBBONS RAWLINGS	20.8	
A-DI0155	8mm	SC	100mm	58mm RND			KELLOW	20.8	
A-DI0162	8mm	SC	81mm	39mm SQ FB			INTERNATIONAL HARVESTER 596, 770	20.8	
A-DI0163	8mm	SC	88mm	46mm RND			MILLER, DELMADE, SHEARER, BALDAN	20.8	
A-DI0167	8mm	SC	100mm	43mm RND			TATU OFFSET	20.8	
<b>28" Plain</b>									
A-DI0163	6mm	Plain	105mm	28.6mm RND	5 x 12mm CSK	104.77mm	MASSEY FERGUSON	19.6	
A-DI0165	6mm	Plain	105mm	32mm SQ	4 x 13.5mm CSK	115mm	CONNOR SHEA NAPIER, BONEL, INTERNATIONAL HARVESTER	19.6	
<b>28" Labrador—Fluted</b>									
A-DI0167CLA	6mm	Fluted	105mm	39mm & 41mm SQ			CONNOR SHEA NAPIER, SHEARER, BONEL. JARRETT, HODGE	18.6	
A-DI0168CLA	6mm	Fluted	105mm	100mm RND	6 x 22mm	92.5mm	GRIZZLY S SERIES	18.6	
A-DI0170CLA	6mm	Fluted	105mm	78mm RND	6 x 22mm	95mm	BONEL, ENNOR	18.6	
A-DI0185CLA	6mm	Fluted	105mm	54mm & 60mm SQ			INTERNATIONAL HARVESTER 3-5, SHEARER 700	18.6	
A-DI0169CLA	8mm	Fluted	105mm	100mm RND	6 x 22mm	92.5mm	GRIZZLY S SERIES, BELMAC	25.2	
A-DI0171CLA	8mm	Fluted	105mm	78mm RND	6 x 22mm	95mm	BONEL, ENNOR	25.2	

30 day trading account available to approved applicants. Contact Paul for an account application form. Email: paul@atcgroup.com.au



ATC Part Number	Thick mm	Type	Dish mm	Centre Hole RND=Round SQ=Square NCH=No Hole FB=Flat Back	Radial Holes CSK=Counter sunk SQ=Square	PCR Pitch circle radius.	Applications	KG	Price Ea
<b>28" Labrador—Fluted continued</b>									
A-DI0175CLA	8mm	Fluted	105mm	39mm & 41mm SQ			CONNOR SHEA NAPIER, JARRETT, HODGE, BONEL	25.2	
A-DI0177CLA	8mm	Fluted	105mm	46mm RND			DELMAD, BALDEN	25.2	
A-DI0178CLA	8mm	Fluted	105mm	52mm RND			COUNTRY WIDE, EZEON, STEIGER, MILLER	25.2	
A-DI0179CLA	8mm	Fluted	105mm	39mm SQ FB			INTERNATIONAL HARVESTER 770	25.2	
A-DI0183CLA	8mm	Fluted	105mm	43mm RND			TATU OFFSET	25.2	
<b>28" Scalloped</b>									
A-DI0166C	6mm	SC	70mm	39mm & 41mm SQ			TAYLORWAY, HODGE	17.7	
A-DI0167C	6mm	SC	92mm	39mm & 41mm SQ			CONNOR SHEA NAPIER, SHEARER, BONEL. JARRETT, HODGE	17.7	
A-DI0168C	6mm	SC	110mm	100mm RND	6 x 22mm	92.5mm	GRIZZLY S SERIES	17.7	
A-DI0170C	6mm	SC	110mm	78mm RND	6 x 22mm	95mm	BONEL, ENNOR	17.7	
A-DI0185C	6mm	SC	92mm	54mm & 60mm SQ			INTERNATIONAL HARVESTER 3-5, SHEARER 700	17.7	
A-DI0179-6	6mm	SC	92mm	39mm SQ FB			INTERNATIONAL HARVESTER 770	17.7	
A-DI0171	8mm	SC	110mm	78mm RND	6 x 22mm	95mm	BONEL, ENNOR	25.2	
A-DI0169	8mm	SC	110mm	100mm RND	6 x 22mm	92.5mm	GRIZZLY S SERIES, BELMAC	25.2	
A-DI0175C	8mm	SC	92mm	39mm & 41mm SQ			CONNOR SHEA NAPIER, JARRETT, HODGE, BONEL	25.2	
A-DI0177	8mm	SC	92mm	46mm RND			DELMAD, BALDEN	25.2	
A-DI0178C	8mm	SC	105mm	52mm RND			COUNTRY WIDE, EZEON, STEIGER, MILLER	25.2	
A-DI0179C	8mm	SC	105mm	39mm SQ FB			INTERNATIONAL HARVESTER 770	25.2	
A-DI0183C	8mm	SC	105mm	43mm RND			TATU OFFSET	25.2	
A-DI028102SB	10mm	SC	104mm	100mm RND	6 x 22mm	92.5mm	GRIZZLY S SERIES, BELMAC	30	

All pricing is shown as exclusive of GST. Items are not sold as original equipment parts



Email: paul@atcgroup.com.au Phone: 07 3285 7777 Mobile: 0448 588 433

ATC Part Number	Thick mm	Type	Dish mm	Centre Hole RND=Round SQ=Square NCH=No Hole FB=Flat Back	Radial Holes CSK=Counter sunk SQ=Square	PCR Pitch circle radius.	Applications	KG	Price Ea
<b>30" Scalloped</b>									
A-DI0187	8mm	SC	105mm	100mm RND	6 x 22mm	92.5mm	GRIZZLY S SERIES	27	
<b>32" Scalloped</b>									
A-DI0190	8mm	SC	122mm	45mm SQ FB			INTERNATIONAL HARVESTER 780	30.6	
A-DI0208	8mm	SC	122mm	78mm RND	6 x 22mm	95mm	ENNOR	30.6	
A-DI0193C	10mm	SC	112mm	59mm SQ & 62mm RND			ALFARM 080, TOWNER 620	39	
A-DI0199S	10mm	SC	122mm	100mm RND	6 x 22mm	92.5mm	GRIZZLY S SERIES	39	
A-DI032210	10mm	SC	122mm	78mm	6 x 22mm	95mm	ENNOR	39	
A-DI0195	12mm	SC	122mm	65mm SQ			CONNOR SHEA, GIANT	50	
A-DI0196C	12mm	SC	122mm	59mm SQ & 62mm RND			ALFARM 080, TOWNER 620	50	
<b>36" Scalloped</b>									
A-DI208	12mm	SC	130mm	64mm RND	6 x 18mm CSK	127mm	SAVANNAH	63	
A-36122SB	12mm	SC	123mm	100mm RND	6 x 22mm	92.5mm	GRIZZLY TINY 290, 390	63	



ATC's plain, labrador "fluted", and scalloped discs are manufactured from boron steel that delivers a Rockwell hardness up to an astonishing 52 Rc without causing brittleness or loss of elasticity. Compared to high carbon steel discs, there's just no comparison. When discs hit hard objects that they can't cut, it has to yield the right way. It's important for discs to be engineered for the ideal compromise between hardness and flexibility. The discs ATC supply are continually tested for flexibility and have the ability to withstand stress and fractures.

Email: [paul@atcgroup.com.au](mailto:paul@atcgroup.com.au) Phone: 07 3285 7777 Mobile: 0448 588 433

WEB: [www.atcgroup.com.au](http://www.atcgroup.com.au)



**Coulters available in plain,  
radial, wavy and fluted  
styles.**



ATC Part Number	Thick mm	Type	Centre Hole RND=Round SQ=Square NCH=No Hole FB=Flat Back	Radial Holes CSK=Counter sunk SQ=Square	PCR Pitch circle radius.	Applications	KG	Price Ea
<b>Coulters 11 1/4"</b>								
A-CO6100	4mm	Double Bevel	72mm RND	5 x 9mm	48mm	Connor Shea 470 drill	1.7	
A-CO6151	4mm	Double Bevel	45mm RND	5 x 7mm	48mm	Aitchison	1.7	
<b>Coulters 12"</b>								
A-CO6242	3mm	Double Bevel	49.2mm RND	6 x 6.3mm	36.5	Bettinson	1.8	
<b>Coulters 12 1/2"</b>								
A-CO6281	3mm	Double Bevel	52mm RND	8 x 10mm	47.5mm	Duncan Clough	1.8	
A-6281R	3mm	38 Ripples	52mm RND	8 x 10mm	47.5mm	Duncan Clough	1.8	
A-CO1208T	3mm	25 Waves	52mm RND	8 x 10mm	47.5mm	Duncan Clough	1.8	
<b>Coulters 13"</b>								
A-CO6337	5mm	Double Bevel	50mm RND	7 x 7mm	50.5mm	Shearer	3.7	
<b>Coulters 13 1/2"</b>								
A-CO6336	3mm	Double Bevel	72mm RND	5 x 9mm	48mm	Connor Shea 470, 8000 Drill	2	

References to OEM brands and part numbers are for identification purposes only. Items are not sold as original equipment parts.

Email: paul@atcgroup.com.au Phone: 07 3285 7777 Mobile: 0448 588 433



ATC Part Number	Thick mm	Type	Centre Hole RND=Round SQ=Square NCH=No Hole FB=Flat Back	Radial Holes CSK=Counter sunk SQ=Square	PCR Pitch circle radius.	Applications	KG	Price Ea
<b>Coulters 14"</b>								
A-CO6350	3mm	Single Bevel	49.2mm RND	6 x 6.35mm	36.5mm	Bettinson	2.4	
A-CO6357	4mm	Double Bevel	64mm RND	5 x 14mm	54mm	HT Holden Hub	3.2	
<b>Coulters 15"</b>								
A-CO6380	3mm	Single Bevel	30mm RND	6 x 8mm	37.2mm	CJD & Kinze Planters	3.5	
A-CO1504	4mm	Single Bevel	38.5mm RND	6 x 8.3mm	38.1mm	PHM	3.6	
A-CO1504S	4mm	Single Bevel Scalloped	38.5mm RND	6 x 8.3mm	38.1mm	PHM	3.6	
A-CO1505	4mm	Single Bevel	60mm RND	6 x 10mm	45mm	Sow Ezy	3.6	
A-CO1505S	4mm	Single Bevel Scalloped	60mm RND	6 x 10mm	45mm	Sow Ezy	3.6	
A-CO1506	4mm	Single Bevel	NCH	6 x 8mm	35mm	Horsch Serto	3.6	
<b>Coulters 16"</b>								
A-CO6425	3mm	Single Bevel	25mm RND	6 x 7mm	36.5mm	Mason planter, Excel Planter	3.2	
A-CO6407	4mm	Double Bevel	64mm RND	5 x 14mm	54mm	HT Holden Hub	4.2	
A-CO6424	4mm	Single Bevel	25mm RND	6 x 7mm	36.5mm	Mason planter, Excel Planter	4.2	
A-CO6426	4mm	Single Bevel	45mm RND	4 x 10.5mm	38mm	Excel Planter	4.2	
A-CO6430	4mm	Single Bevel	75mm RND	5 x 13mm SQ	54mm	Excel Stubble Warrior	4.2	
A-CO6433	4mm	Single Bevel	75mm RND	5 x 13.5mm	54mm	Excel Stubble Warrior	4.2	
A-CO6434	4mm	Single Bevel	75mm RND	5 x 13.5mm CSK	54mm	Excel Stubble Warrior (Radial holes CSK)	4.2	
A-CO1635W	4mm	Fluted	64mm RND	5 x 14mm	54mm	HT Holden Hub	4.2	
A-CO1635D2	4mm	20 Wave	64mm RND	5 x 14mm	54mm	HT Holden Hub	4.2	

ATC Part Number	Thick mm	Type	Centre Hole RND=Round SQ=Square NCH=No Hole FB=Flat Back	Radial Holes CSK=Counter sunk SQ=Square	PCR Pitch circle radius.	Applications	KG	Price Ea
<b>Coulters 17.5"</b>								
A-CO6438	4mm	8 Wave	89mm RND	4 x 14.3mm	66.7mm	Gyral Planter	4.5	
<b>Coulters 17.7" and 18"</b>								
A-CO6440	4mm	12 Wave	64mm RND	5 x 14mm	54mm	HT Holden Hub	5.5	
A-CO6441	4mm	24 Wave	64mm RND	5 x 14mm	54mm	HT Holden Hub	5.5	
A-CO6457	4mm	Double Bevel	64mm RND	5 x 14mm	54mm	HT Holden Hub	5.5	
A-CO6473	4mm	50 Ripples	64mm RND	5 x 14mm	54mm	HT Holden Hub	5.5	
A-CO1860D2	4mm	20 Wave	64mm RND	5 x 14mm	54mm	HT Holden Hub	5.5	
A-CO6461	4mm	12 Wave	101.6mm RND	4 x 13.5mm	66.7mm	Great Plains	6	
A-CO1880D2	4mm	20 Wave	101.6mm RND	4 x 13.5mm	66.7mm	Great Plains	6	
A-CO6472	6mm	Single Bevel	64mm RND	5 x 14mm	54mm	HT Holden Hub	7	
A-CO6480	5mm	Single Bevel	77mm RND	4 x 10.3mm	55.85mm	John Deere, Grays Planter	6.5	
A-CO6481	5mm	Single Bevel	92.7mm	4 x 15.8mm	63.5mm	Flexicoil Disc Openers, Boss, Pillar	6.5	
A-CO6482	6mm	Single Bevel	77mm RND	4 x 10.3mm	55.85mm	John Deere, Grays and Ingersoll Planters	7	
<b>Coulters 20" and 21"</b>								
A-CO6507	4mm	Double Bevel	64mm RND	5 x 14mm	54mm	HT Holden Hub	6.7	
A-CO2060D2	5mm	20 Wave	64mm RND	5 x 14mm	54mm	HT Holden Hub	6.7	
A-CO6522	6mm	Double Bevel	64mm RND	5 x 14mm	54mm	HT Holden Hub	9.5	
A-CO6523	6mm	Single Bevel	64mm RND	5 x 14mm	54mm	Janke, Gessner Root Cutter, Austil	9.5	
A-CO6530	6mm	Double Bevel	81mm RND	5 x 13mm	54mm	HT Holden Hub, Excel	9.5	

30 day trading account available to approved applicants. Contact Paul for an account application form. Email: paul@atcgroup.com.au



ATC Part Number	Thick mm	Type	Centre Hole RND=Round SQ=Square NCH=No Hole FB=Flat Back	Radial Holes CSK=Counter sunk SQ=Square	PCR Pitch circle radius.	Applications	KG	Price Ea
<b>Coulters 24"</b>								
A-CO6624	6mm	Double Bevel	102mm RND	5 x 16mm	70mm	Noble Blade Plough	12	
A-CO6627	6mm	Double Bevel	64mm RND	5 x 14mm	54mm	HT Holden Hub, Tobin Speed Drill	12	
A-CO2440	8mm	Single Bevel	95mm RND	4 x 13mm	63.5mm	Mine - Daybreak	16	
<b>Coulters 26"</b>								
A-CO6667	6mm	Double Bevel	46mm RND	4 x 18mm	82.5mm	Hodge	18	
A-CO6668	6mm	Double Bevel	52mm RND	4 x 14mm	82.5mm	Hodge	18	
A-CO6672	8mm	Single Bevel	108mm RND	6 x 14mm	70mm	Excel	24	
<b>Coulters 30"</b>								
A-CO6776	9mm	Double Bevel	46mm RND	4 x 18mm	82.5mm	Hodge	37	
A-CO6777	9mm	Double Bevel	108mm RND	6 x 14mm	70mm	Excel	37	

**Coultor Types: Plain, Wave, Fluted, Radial**

8 wave coulters are suitable for sandy soils because of its waves and great tilled strip width. These do require effort for soil penetration.

12 wave coulters are suitable for sandy, very damp and sticking soils. Less vertical effort to penetrate into the ground than a 8 wave coultor.

25 wave fluted and radial coulters suitable for clay soils regularly used for minimum till. Less effort for soil penetration, good performance cutting straw.

20 wave radial coulters provides excellent vertical cutting of residue good soil penetration and reduce soil stirring and narrow tilled strip.

50 wave fluted and 30 wave radial coulters used for planting grass on no till clayish soils. Good soil penetration, fluted great for straw cutting, superb rotating performance.

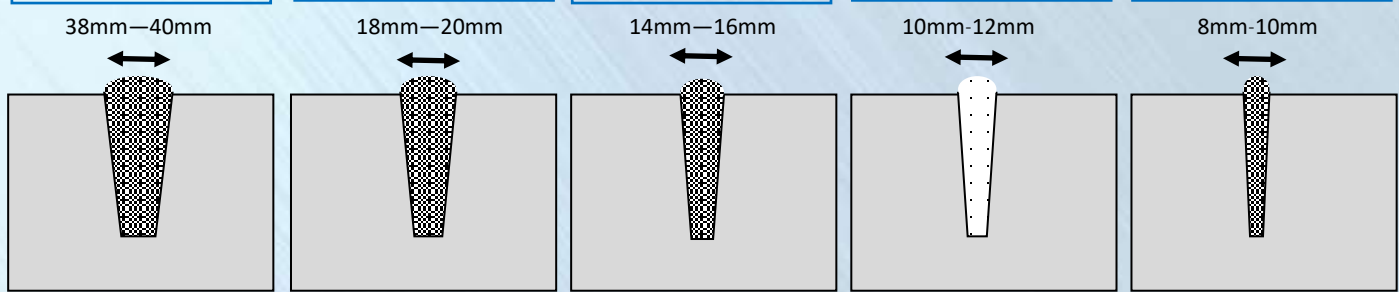

Email: paul@atcgroup.com.au Phone: 07 3285 7777 Mobile: 0448 588 433

WEB: www.atcgroup.com.au







## Ground Engaging Wearparts

### Points & Sweeps



ATC Group supply a range of GWT and Nicols points and sweeps. Each sweep is manufactured from high-quality hardened steel which results in significantly better wear resistance.

To provide you with the absolute best in wear life, ATC also supplies tungsten carbide hardfacing options on the full range of our tillage components.

Contact Paul for more details and pricing on our hardfaced applications.

**Phone: 07 3285 7777 or Mobile 0448 588 433**

**Email: [sales@atcgroup.com.au](mailto:sales@atcgroup.com.au) WEB [www.atcgroup.com.au](http://www.atcgroup.com.au)**

Bolt on Reversible Chisel Plough Points						
ATC Part No	Width	Thickness	Hole Size	Hole Centres	Suits	Price Ea
A-CP31SL1	40mm	12mm	2 x 7/16"	50mm	IH, Vibrashank and MF	
A-CP31SL2	40mm	16mm	2 x 7/16"	50mm	IH, Vibrashank and MF	
A-CP31SL3	50mm	16mm	2 x 7/16"	50mm	Massey, Pioneer, McKay coil tines	
A-CP31SL4	65mm	16mm	2 x 7/16"	50mm	Massey, Pioneer, McKay coil tines	
A-CP31H	40mm	12mm	3 x 9/16"	50mm	Howard	
A-CP31F2	50mm	8mm	2 x 7/16"	44mm-51mm	MF, Tiller, David Brown coil tines	
A-CP31F21/2	64mm	8mm	2 x 7/16"	44mm-51mm	MF, Tiller, David Brown coil tines	
A-CP12640	64mm	10mm	2 x 7/16"	44mm-51mm	25mm and 32mm coil	
A-CP31SH	50mm	16mm	2 x 9/16"	76mm	Shearer Trashworker, Econcraft, Ford	
A-CP31SHH	50mm	20mm	2 x 9/16"	76mm	Shearer Trashworker, Econcraft, Ford	
A-CP31CS	64mm	12mm	2 x 1/2"	63.5mm	Connor Shea	
A-CP31DJ	50mm	12mm	2 x 1/2"	57mm	JD, Morris, Gason, various Nth American	
A-CP31M	50mm	16mm	2 x 1/2"	57mm	JD, Morris, Gason, various Nth American	
A-CP31MH	50mm	20mm	2 x 1/2"	57mm	JD, Morris, Gason, various Nth American	
A-CP31JB	64mm	12mm	2 x 1/2"	57mm	Berends, Jarrett, Yeoman and Bonel	
A-CP31MG3	75mm	19mm	2 x 5/8"	57mm	Gessner	



A-CP31SL Style



A-CP31SH / A-CP31MH Style



A-CP12640 / A-CP31F Style

**ATC supply points as standard replacement parts or tungsten carbide hardfaced parts for the very best in wear life. Contact Paul for pricing on our hardfaced applications.**

Email: paul@atcgroup.com.au Phone: 07 3285 7777 Mobile: 0448 588 433

WEB: www.atcgroup.com.au



Reversible Ripper Points						
ATC Part No	Width	Thickness	Hole Size	Hole Centres	Suits	Price Ea
A-RP01341	75mm	16mm	2 x 1/2"	51mm	Various	
A-RP01344	75mm	19mm	2 x 1/2"	51mm	Various	
A-RP01345	75mm	16mm	2 x 1/2"	63mm	Various	
A-RP01348	75mm	16mm	2 x 1/2"	70mm	Various	
A-RP01349	64mm	19mm	4 x 1/2"	51mm-112mm	Various	
A-RP06275	75mm	19mm	4 x 1/2"	51mm-112mm	Various	
A-RP01352	75mm	16mm	2 x 1/2"	70mm	Various	
A-RP01353	75mm	25mm	2 x 1/2"	115mm	Various	

ATC supply points as standard replacement or tungsten carbide hardfaced for the very best in wear life. Contact Paul for pricing on our hardfaced applications.



61U Universal Bolt on Points 38 Degree				
ATC Part No	Size	Thickness	Suits	Price Ea
A-UBOP21/2	2/12"	6mm	Plain suits Shearer, Ford, Gyril, various	
A-UBOP4	4"	6mm	Dart suits Shearer, Ford, Gyril, various	
A-UBOP5	5"	6mm	Dart suits Shearer, Ford, Gyril, various	
A-UBOP6	6"	6mm	Dart suits Shearer, Ford, Gyril, various	
A-UBOP7	7"	6mm	Dart suits Shearer, Ford, Gyril, various	
A-UBOP8	8"	6mm	Dart suits Shearer, Ford, Gyril, various	



Crush Head Bolt & Nut to suit 61U Points		
F-CHB13/4 x7/16	1 3/4" x 7/16"	
F-CHB17/8x7/16	1 7/8" x 7/16"	
F-CHB21/8x7/16	2 1/8" x 7/16"	



All pricing is shown as exclusive of GST.



30 day trading account available to approved applicants. Contact Paul for an account application form. Email: [paul@atcgroup.com.au](mailto:paul@atcgroup.com.au)

43 Degree bolt on Cultivator Sweeps						
ATC Part No	Width	Thick	Bolt Holes	Centres	Suits	Price Ea
A-CPS60606	6"	8mm	2 x 7/16"	44mm	IHC, Vibrashank, Verstile, AFM, Gyrat, Janke. Suit 43 degree tynes. Can use either 7/16" or 1/2" plough bolts.	
A-CPS60608	8"	8mm	2 x 7/16"	44mm		
A-CPS606010	10"	8mm	2 x 7/16"	44mm		
43 Degree bolt on Cultivator SUPA Wing Sweeps						
A-CPS43010SW	10"	8mm	2 x 7/16"	44mm	AFM, Gyrat Penetrator, Janke and various. 43 degree tynes. Can use either 7/16" or 1/2" plough bolts.	
A-CPS43012SW	12"	8mm	2 x 7/16"	44mm		
A-CPS43014SW	14"	8mm	2 x 7/16"	44mm		
Bolt on Sweeps suit 3PL Cultivators using Coil Tynes						
A-CPS53006	6"	6mm	2 x 7/16"	44mm-51mm	Ford Crown, Harvey, MF, Pioneer, Agpoint, ASP coil tynes. Use 7/16 plough bolts.	
A-CPS53008	8"	6mm	2 x 7/16"	44mm-51mm		
A-CPS53010	10"	6mm	2 x 7/16"	44mm-51mm		
A-CPS53012	12"	6mm	2 x 7/16"	44mm-51mm		
47 Degree Cultivator & Air Seeder Sweeps						
A-CPS50508	8"	8mm	2 x 7/16"	44mm	Flexi-coil, Bourgault, Horwood Bagshaw, Gason, Simplicity, IH Vibrashank, and various with 47 degree tynes. Use 7/16" or 1/2" plough bolts.	
A-CPS50510	10"	8mm	2 x 7/16"	44mm		
A-CPS50512	12"	8mm	2 x 7/16"	44mm		
A-CPS50514	14"	8mm	2 x 7/16"	44mm		
47 Degree Cultivator SUPA Wing Sweeps						
					Flexi-coil, Bourgault, Horwood Bagshaw, Gason, Simplicity, IH Vibrashank, and various with 47 degree tynes. Use 7/16" or 1/2" plough bolts.	
A-CPS47010SW	10"	8mm	2 x 7/16"	44mm		
A-CPS47012SW	12"	8mm	2 x 7/16"	44mm		
A-CPS47014SW	14"	8mm	2 x 7/16"	44mm		



50 Degree bolt on Chisel Plough Sweeps						
ATC Part No	Width	Thick	Bolt Holes	Centres	Suits	Price Ea
A-CPS50008	8"	8mm	2 x 1/2"	57mm	Versatile, John Deere, Alfarm, Gason, Gessner, Horwood Bagshaw, Yeoman, AFM, Hesston, Noble, Leon, Callow Big Rig, Bourgault, Flexi-Coil, Riteway, Morris. Suit 50 degree tynes. Use 1/2" plough bolts.	
A-CPS50010	10"	8mm	2 x 1/2"	57mm		
A-CPS50012	12"	8mm	2 x 1/2"	57mm		
A-CPS50014	14"	8mm	2 x 1/2"	57mm		
A-CPS50016	16"	8mm	2 x 1/2"	57mm		
A-CPS50018	18"	8mm	2 x 1/2"	57mm		
50 Degree bolt on Chisel Plough Supa Wing Sweeps						
A-CPS50012SW	12"	8mm	2 x 1/2"	57mm	Versatile, John Deere, Riteway, Yeomans, AFM, Hesston, Noble, Leon, Flexi-coil. Suits 50 degree tynes. Use 1/2" Plough Bolts.	
A-CPS50014SW	14"	8mm	2 x 1/2"	57mm		
A-CPS50016SW	16"	8mm	2 x 1/2"	57mm		
A-CPS50018SW	18"	8mm	2 x 1/2"	57mm		
A-CP15916SW	16"	8mm	2 x 9/16"	76mm	Shearer Trashworker & Econdraft Banana Farming. Use 9/16" Trashworker plough bolts.	
A-CP15918SW	18"	8mm	2 x 9/16"	76mm		
50 Degree Penetrator Sweeps						
A-CPS50008PS	8"	8mm	2 x 1/2"	57mm	Penetrator style suits Versatile, John Deere, Yeoman, AFM, Hesston, Noble, Leon, Flesi-coil, Riteway. Use 1/2" plough bolts.	
A-CPS50010PS	10"	8mm	2 x 1/2"	57mm		
A-CPS50010PS	12"	8mm	2 x 1/2"	57mm		
A-CPS50012PS	14"	8mm	2 x 1/2"	57mm		
A-CPS50014PS	16"	8mm	2 x 1/2"	57mm		
A-CPS50016PS	18"	8mm	2 x 1/2"	57mm		



ATC supply points as standard replacement or tungsten carbide hardfaced for the very best in wear life. Contact Paul for pricing on our hardfaced applications.



All pricing is shown as exclusive of GST. Items are not sold as original equipment parts.

Email: paul@atcgroup.com.au Phone: 07 3285 7777 Mobile: 0448 588 433

50 Degree Ultra Wing Chisel Plough Sweeps						
ATC Part No	Width	Thick	Bolt Holes	Centres	Suits	Price Ea
A-CPS5012UW	12"	5/16"	2 x 1/2"	57mm	Versatile, John Deere, Riteway, Yeoman, AFM, Hesston, Noble, Leon, Flexi-coil. 50 degree tynes. Use 1/2" plough bolts. Genuine Nichols part.	
A-CPS5014UW	14"	5/16"	2 x 1/2"	57mm		
A-CPS5016UW	16"	5/16"	2 x 1/2"	57mm		
Shearer Trashworker Sweeps						
A-CPS15908TW	8	8mm	2 x 9/16"	76mm	Shearer Trashworker and Econodraft, Banana Farming Co-Multiworker. Use 9/16" special plough bolts	
A-CPS15912TW	12	8mm	2 x 9/16"	76mm		
A-CPS15914TW	14	8mm	2 x 9/16"	76mm		
A-CPS15916TW	16	8mm	2 x 9/16"	76mm		
A-CPS15918TW	18	8mm	2 x 9/16"	76mm		
Shearer Trashworker "Digger Style" Sweeps						
A-CPS16411TWD	11"	8mm	2 x 9/16"	76mm	Shearer Trashworker and Econodraft, Banana Farming Co-Multiworker. Use 9/16" special plough bolts	
A-CPS16416TWD	16"	8mm	2 x 9/16"	76mm		
A-CPS16418TWD	18"	8mm	2 x 9/16"	76mm		
Shearer Trashworker Ultra Wing Sweeps						
A-CPS5416TWU	16"	5/16"	2 x 9/16"	76mm	As Above	
A-CPS5418TWU	18"	5/16"	2 x 9/16"	76mm		



ATC supply points as standard replacement or tungsten carbide hardfaced for the very best in wear life. Contact Paul for pricing on our hardfaced applications.

Email: paul@atcgroup.com.au Phone: 07 3285 7777 Mobile: 0448 588 433

WEB: www.atcgroup.com.au



CSK Plough Bot & Nut Sets			Special AG Headed Bolt & Nut Sets		
ATC Part No	Description	Price Ea	ATC Part No	Description	Price Ea
F-BPC7/16x13/4	7/16" x 1 3/4"		F-AGH3/8x13/4	3/8" x 1 3/4"	
F-BPC7/16x2	7/16" x 2"		F-AGH3/8x2	3/8" x 2"	
F-BPC7/16x21/4	7/16" x 2 1/4"		F-AGH7/16x13/4	7/16" x 1 3/4"	
F-BPC7/16x21/2	7/16" x 2 1/2"		F-AGH7/16x17/8	7/16 x 1 7/8"	
F-BPC7/16x3	7/16" x 3"		F-AGH7/16x21/8	7/16" x 2 1/8"	
F-BPC1/2x11/2	1/2" x 1 1/2"		F-AGH7/16x21/4	7/16" x 2 1/4"	
F-BPC1/2x13/4	1/2" x 1 3/4"		F-AGH7/16x21/2	7/16" x 2 1/2"	
F-BPC1/2x2	1/2" x 2"		Shearer Trashworker Bolt & Nut Sets		
F-BPC1/2x21/4	1/2" x 2 1/4"		F-SHTW9/16x21/4	9/16" x 2 1/4"	
F-BPC1/2x21/2	1/2" x 2 1/2"		F-SHTW9/16x23/4	9/16" x 2 3/4"	
F-BPC1/2x3	1/2" x 3"				
F-BPC1/2x31/2	1/2" x 3 1/2"				
Crushed Head Bolt & Nut					
F-CHB13/4 x7/16	1 3/4" x 7/16"				
F-CHB17/8x7/16	1 7/8" x 7/16"				
F-CHB21/8x7/16	2 1/8" x 7/16"				



ATC supply points as standard replacement or tungsten carbide hardfaced for the very best in wear life. Contact Paul for pricing on our hardfaced applications.

All pricing is shown as exclusive of GST.



30 day trading account available to approved applicants. Contact Paul for an account application form. Email: [paul@atcgroup.com.au](mailto:paul@atcgroup.com.au)

# NOTES

MACHINE TYPE	MAKE / MODEL	ATC PART NO	PRICE EA	QUANTITY REQ'D

Email: [paul@atcgroup.com.au](mailto:paul@atcgroup.com.au) Phone: 07 3285 7777 Mobile: 0448 588 433

WEB: [www.atcgroup.com.au](http://www.atcgroup.com.au)







## Ground Engaging Wearparts

ATC supply a wide range of replacement hammers and flails for mulchers and flail mowers including brands such as Agrifarm, Agrimaster, Berti, Breviglieri, Cancela, FAE, Falc, Ferri, Faustini, Kuhn, Kverneland, Howard, Kuhn, Maletti, Maschio, McConnel, M.E.A.A.T, Muthing, Nobili, Omarv, Seppi, Sicma, Zanon, Zenith and more.

ATC's drop forged hammers are extremely strong with excellent wearing characteristics and are excellent in weight conformity. ATC flail blades and hammers are manufactured in Italy and Spain from Boron and cast steels and are designed for high ductility and excellent wear. ATC provide the option of having our range of mulcher flails and hammers coated with tungsten carbide hardfacing to provide you with the longest wearing parts available.

ATC's extensive ranged of fixed forestry mulcher teeth, inserts and holders are drop forged and are supplied with tungsten carbide hardfacing as a standard extra. ATC stock replacements for brands such as AFE (Advanced Forestry), AHWI, Augertorque Bobcat, Bradco, Caterpillar, Diamond, Digga, FAE, Fecon, Loftness, Magnum, Quadco, Rayco, Seppi and more.

### Mulching hammers and flails. Forestry mulcher fixed teeth inserts and holders



**Phone: 07 3285 7777 or Mobile 0448 588 433**

**Email: [sales@atcgroup.com.au](mailto:sales@atcgroup.com.au) WEB [www.atcgroup.com.au](http://www.atcgroup.com.au)**

ATC list the original equipment manufacturers part number (OEM) in most cases, however if you need to check that you are ordering the correct part, identifying correct fitment can be ascertained by measurements as below.

	Hole size	16.5mm
	Knuckle width	40mm
	Radius "centre of hole to cutting edge face"	90mm
	Cutting Face	120mm

	Make	Hole Size	Knuckle	Radius	Cutting Face	ATC P/No	Price Ea Standard	Price Ea Hardfaced
	Agrifarm	16mm	40mm	90mm	120mm	A-HASE7387		
Suits Agrifarm ASM Models OEM A-37644								

	Agrimaster	20.5mm	60mm	90mm	145mm	A-HASI7391		
	Suits Agrimaster FA models 175,200,225 OEM 3001119. Also suits Celli Taurus.							

	Agrimaster	31mm	60mm	80mm	70mm	I-WMF04-6080-SS		
	Suits Agrimaster AWP, AWP-S models OEM 3001780 "Single edged"							

	Berti P Type Celli Gemini	16.5mm	40mm	95mm	137mm	A-HABE01		
	Suits Berti TFB/Y, TFB/R, AF, AF/SSL, TBM, TA/P OEM MP0008 Also Celli Gemini 702605							

	Berti A Type	20mm	52mm	95mm	135mm	A-HABE150		
	Berti A Type TFB/Y, TFB/R, TFB/SB, TBM, EKR, TA/P, AF OEM MA3922							









	Berti M Type	20mm	85mm	95mm	135mm	A-HABE250		
	Suits Berti TBM/S, TFH/M, TFB/M Mega OEM MP0794							

ATC's hardfaced parts will greatly extend wear life and will save you time and labour costs due to not having to change out worn parts as often.

Email: paul@atcgroup.com.au Phone: 07 3285 7777 Mobile: 0448 588 433

WEB: www.atcgroup.com.au











	Make	Hole Size	Knuckle	Radius	Cutting Face	ATC P/No	Price Ea Standard	Price Ea Hardfaced
	Berti T Type	30mm	80mm	80mm	75mm	I-WMF04-8080		
	Suits Berti ECF, ECF-SB, ECF-MD models OEM MD1950 "Double edged"							
	Berti T Type	30mm	80mm	80mm	75mm	I-WMF04-8080-SS		
	Suits Berti ECF, ECF-SB, ECF-MD models OEM MD1950 "Single edged"							
	Berti T Type	30mm	80mm	80mm	75mm	I-WMF04-8080-C-WC		
	Suits Berti ECF, ECF-SB, ECF-MD models OEM MD1950 hardfaced top and bottom edges EHD							
	Breviglieri	16.5mm	40mm	95mm	137mm	A-HABE01		
	Suits Breviglieri Flash SR, Turbo T, Master, Super Master OEM 0056123							
	Celli	16.5mm	40mm	110mm	120mm	A-HASE7394		
	Suits Celli Vega OEM 704052 (Note Celli Taurus hammers also stocked item A-HASI7391)							
	FAE	31mm	60mm	80mm	70mm	I-WMF04-6080		
	Suits FAE FML/SSL/HY/FS OEM 111120001 "Double edged"							
	FAE	31mm	60mm	80mm	70mm	I-WMF04-6080-SS		
	Suits FAE FML/SSL/HY/FS OEM 111120000 "Single edge"							
	FALC	25.5mm	54mm	96mm	100mm	A-HAFA65180		
	Suits Falc OEM 66 00 00							











All pricing is shown as exclusive of GST. Items are not sold as original equipment parts.

Email: paul@atcgroup.com.au Phone: 07 3285 7777 Mobile: 0448 588 433

	Make	Hole Size	Knuckle	Radius	Cutting Face	ATC P/No	Price Ea Standard	Price Ea Hardfaced
		Faustini	16mm	40mm	95mm	137mm	A-HABE01	
<b>Suits Faustini FTP models</b>								
	Howard	25.4mm	50mm	175mm	115mm	A-FLN018		
<b>Suits Howard Kronos alternative to Y blades standard version</b>								
	Kuhn	16.5mm	40mm	110mm	120mm	A-HASE7394		
<b>Suits Kuhn JX000049, 6061700</b>								
	Kuhn	25.5mm	51mm	175mm	88mm	A-HANO65444		
<b>Suits Kuhn JX136378 Alternative to Y blade</b>								
	Kuhn	25.4mm	50mm	175mm	115mm	A-FLN018		
<b>Suits Kuhn OEM ref 6061699</b>								
	Kverneland	16.5mm	40mm	110mm	120mm	A-HASE7394		
<b>Suits Kverneland MA6402076 , MA6303076, MA6401076</b>								
	Maletti	16.5mm	40mm	110mm	120mm	A-HASE7394		
<b>Suits Maletti FH, FDP, FRO models OEM MA6402076 , MA6303076, MA6401076</b>								
	Maschio	16.5mm	40mm	110mm	120mm	A-HASE7394		
<b>Suits Maschio BC / BE / BL / Vita / Bela / Tritone / Brava / Giraffa models OEM T24004025</b>								









30 day trading account available to approved applicants. Contact Paul for an account application form. Email: paul@atcgroup.com.au



	Make	Hole Size	Knuckle	Radius	Cutting Face	ATC P/No	Price Ea Standard	Price Ea Hardfaced
		Maschio	20.5mm	60mm	90mm	145mm	A-HASI7391	
<b>Suits Maschio Bisonte, Corazza CR, Giraffa, Griffone, Tigre OEM M03400410</b>								
	McConnel	25.4mm	38mm	135mm	60mm	I-WMF23		
<b>Suits McConnel F10 Hammer OEM 7314366</b>								
	Muthing	16.5mm	40mm	95mm	137mm	A-HABE01		
<b>Suits Muthing MU mulchers</b>								
	M.E.A.A.T	18.5mm	40mm	110mm	120mm	A-HASE7399		
<b>Suits M.E.A.A.T</b>								
	M.E.A.A.T	16.5mm	40mm	110mm	120mm	A-HASE7394		
<b>Suits M.E.A.A.T</b>								
	Nobili	16.5mm	40mm	110mm	120mm	A-HASE7394		
<b>Suits Nobili BNE, TBL, VK, VKE, VKR, WMU models OEM N1891002</b>								
	Nobili	25.4mm	51mm	175mm	88mm	A-HANO65444		
<b>Suits Nobili heavy duty hammer alternative to Y blades</b>								
	Nobili	25.4mm	50mm	175mm	115mm	A-FLN018		
<b>Suits Nobili standard replacement hammer alternative to Y blades OEM ref TX136276</b>								



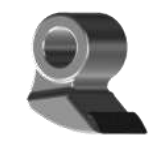







ATC also provide a custom tungsten carbide hardfacing service. With over 20 years experience and robotic and computer aided delivery systems, we are very skilled at what we do. Contact us to discuss your requirements.

	Make	Hole Size	Knuckle	Radius	Cutting Face	ATC P/No	Price Ea Standard	Price Ea Hardfaced
		Orsi	20.5mm	60mm	90mm	150mm	A-HASI7391	
<b>Suits Orsi WPR, WPS, models OEM 00023133. (Also suits Celli Taurus OEM 722580)</b>								
	Orsi	31mm	60mm	80mm	70mm	I-WMF04-6080-SS		
<b>Suits Orsi W Forrest models OEM 00023109 "Single sided"</b>								
	Seppi	16mm	40mm	90mm	120mm	A-HASE7387		
<b>Suits Seppi SMW, SBM models OEM 15002041</b>								
	Seppi	16mm	40mm	110mm	120mm	A-HASE7394		
<b>Suits Seppi SMO, S9, WBS, OLS, models OEM 13002001</b>								
	Seppi	31mm	60mm	70mm	65mm	I-WMF04-6070		
<b>Suits Seppi OPT-240 Miniforst, Midiforst, Midiforst DT, Superforst, Forst M "Double Edge"</b>								
	Seppi	31mm	60mm	80mm	70mm	I-WMF04-6080-SS		
<b>Suits Seppi Miniforst, Midiforst, Midiforst DT, Superforst, Forst M "Single Edge"</b>								
	Seppi	31mm	60mm	70mm	65mm	I-WMF04-6070		
<b>Suits Seppi Miniforst, Midiforst, Midiforst DT, Superforst, Forst M "Double Edge"</b>								

All pricing is shown as exclusive of GST. Items are not sold as original equipment parts.

Email: paul@atcgroup.com.au Phone: 07 3285 7777 Mobile: 0448 588 433





	Make	Hole Size	Knuckle	Radius	Cutting Face	ATC P/No	Price Ea Standard	Price Ea Hardfaced
	Seppi	31mm	60mm	70mm	60mm	I-WMF04-6070-2T		
<b>Suits Seppi Miniforst, Midiforst, Midiforst DT, Superforst, Forst M. With 2 tungsten tiles.</b>								
	Sicma - Cosmag	20.5mm	60mm	90mm	150mm	A-HASI7391		
<b>Suits Sicma Cosmag models. (Also suits Celli Taurus OEM 722580)</b>								
	Tuffass	16mm	40mm	90mm	120mm	A-HASE7387		
<b>FTP Range</b>								
	Zanon - Ino	16mm	40mm	90mm	120mm	A-HASE7387		
<b>Suits Zanon TFZ, TRV, RFG, TMC, TMH models RM8 and Ino models</b>								
	Zanon	16mm	40mm	90mm	120mm	A-HASE7387		
<b>Suits Zanon TFG, TFA, LFG, TRG, TPE models RM66</b>								
	Zanon	25.4mm	50mm	175mm	115mm	A-FLN018		
<b>Suits Zanon TSF, ZTS RM46</b>								
	Zanon	31mm	60mm	80mm	70mm	I-WMF04-6080-SS		
<b>Suits Zanon TM, TF, DT forestry mulcher models RM99 "Single sided"</b>								
	Zenit	25.5mm	54mm	96mm	100mm	A-HA65180		
<b>Suits Zenit models</b>								

All pricing is shown as exclusive of GST.



30 day trading account available to approved applicants. Contact Paul for an account application form. Email: paul@atcgroup.com.au

	Make	Hole Size	Knuckle	Radius	Cutting Face	ATC P/No	Price Ea Standard	Price Ea Hardfaced
		TMC Cancela	28.5mm	80mm	98mm	110mm	A-HACAA04	
TMC Cancela suits TDE, TDR, TMS models OEM Ref TMC001836-02 / A04 hammer								
	TMC Cancela	28.5mm	60mm	98mm	151mm	A-HACAA18		
TMC Cancela suits TG OEM Ref TMC022377-1 / A18 hammer								
	Zanon	20.5mm	70mm	160mm	160mm	A-HAZARM69		
Zanon suits TM models OEM 5350098 / RM69								

### Notes

MACHINE TYPE	MAKE / MODEL	ATC PART NO	PRICE EA	QUANTITY REQ'D

All pricing is shown as exclusive of GST. Items are not sold as original equipment parts.

Email: paul@atcgroup.com.au Phone: 07 3285 7777 Mobile: 0448 588 433





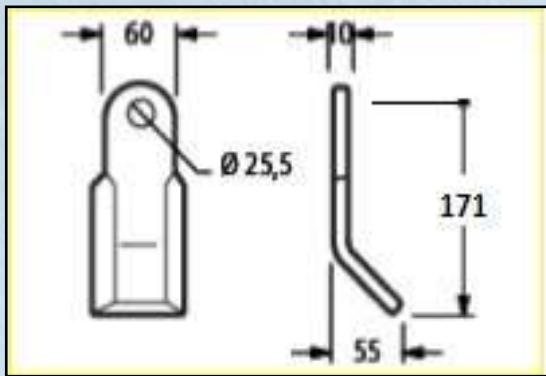

ATC's range of mulcher flail blades are manufactured using Boron steel. Tungsten carbide hardfaced blades can be ordered to greatly extend the wear life of the mulching flails.

Hole size	25.5mm
Width	60mm
Thickness	10mm
Length "centre of hole to end of flail"	171mm

	Make	Hole Size	Width	Thickness	Length	ATC P/No	Price Ea Standard	Price Ea Hardfaced
		Agrifarm	25.5mm	60mm	10mm	171mm	A-FLNO16	

**Y blade suits Agrifarm mulcher AMM, ACM, AHM models OEM A-37094**

	Agrifarm	25.5mm	60mm	10mm	171mm	A-FLNO17		
--	----------	--------	------	------	-------	----------	--	--

**Straight blade suits Agrifarm mulcher AMM, ACM, AHM models**

	Agrimaster	25.5mm	60mm	8mm	118mm	A-FLAG65222		
---	------------	--------	------	-----	-------	-------------	--	--

**Y Blade suits Agrimaster MKD Series OEM Ref 3000106**

	Agrimaster	25.5mm	60mm	8mm	118mm	A-FLAG84415		
---	------------	--------	------	-----	-------	-------------	--	--

**Straight blade suits Agrimaster MKD Series**

	Berti	28.5mm	60mm	10mm	171mm	A-FLBER01		
---	-------	--------	------	------	-------	-----------	--	--

**Y Blade suits Berti TSB / TSP-P OEM Ref C601OF28 Bush to suit F-FLBER01/02**

	Berti	28.5mm	60mm	10mm	171mm	A-FLBER02		
---	-------	--------	------	------	-------	-----------	--	--







**Straight Blade suits Berti TSB / TSP-P OEM Ref C6008F28 Bush to suit F-FLBER01/02**

ATC supply quality parts manufactured using European Boron steel. Adding ATC tungsten carbide hardfacing greatly increases the wear life of parts.

Email: paul@atcgroup.com.au Phone: 07 3285 7777 Mobile: 0448 588 433

WEB: www.atcgroup.com.au



	Make	Hole Size	Width	Thickness	Length	ATC P/No	Price Ea	Price Ea
							Standard	Hardfaced
	Breviglieri	25.5mm	60mm	10mm	171mm	A-FLNO16		
<b>Y blade suits various Breviglieri mulchers OEM 55202</b>								
	Breviglieri	25.5mm	60mm	10mm	171mm	A-FLNO17		
<b>Straight blade suits various Breviglieri mulchers</b>								
	Celli	25.5mm	60mm	10mm	171mm	A-FLNO16		
<b>Y blade suits Celli Scorpio and Orion mulchers</b>								
	Celli	25.5mm	60mm	10mm	171mm	A-FLNO17		
<b>Straight blade suits Celli Scorpio and Orion mulchers</b>								
	Falc	25.5mm	60mm	10mm	171mm	A-FLNO16		
<b>Y blade suits Falc mulchers OEM F43.01.51</b>								
	Falc	25.5mm	60mm	10mm	171mm	A-FLNO17		
<b>Straight blade suits various Falc mulchers</b>								
	Falc	25.5mm	60mm	10mm	171mm	A-FLNO15		
<b>"L" style blade suits various Falc mulchers</b>								











ATC's tungsten carbide hardfaced flail mower blades generally get 3-4 times greater wear life compared to standard non hardfaced blades. The hardfaced blades retain their length of cut much longer allowing for continued use.

References to OEM brands and part numbers are for identification purposes only. Items are not sold as original equipment parts.



Email: paul@atcgroup.com.au Phone: 07 3285 7777 Mobile: 0448 588 433

	Make	Hole Size	Width	Thickness	Length	ATC P/No	Price Ea Standard	Price Ea Hardfaced
		Ferri	25.5mm	60mm	8mm	118mm	A-FLAG65222	
<b>Y blade suits Ferri mulchers</b>								
	Ferri	25.5mm	60mm	8mm	118mm	A-FLAG84415		
	<b>Straight blade suits Ferri mulchers</b>							
	Howard	25.5mm	60mm	10mm	171mm	A-FLNO16		
	<b>Y blade suits Howard Kronos models</b>							
	Howard	25.5mm	60mm	10mm	171mm	A-FLNO17		
	<b>Straight blade suits Howard Kronos models</b>							
	Howard	25.5mm	60mm	10mm	171mm	A-FLNO15		
	<b>"L" style blade suits Howard Kronos models</b>							
	Kuhn	25.5mm	60mm	10mm	171mm	A-FLNO16		
	<b>Y blade suits Kuhn mulcher</b>							
	Kuhn	25.5mm	60mm	10mm	171mm	A-FLNO17		
	<b>Straight blade suits Kuhn mulcher</b>							
	Kuhn	25.5mm	60mm	10mm	171mm	A-FLNO15		
	<b>"L" style blade suits Kuhn mulcher</b>							









	Make	Hole Size	Width	Thickness	Length	ATC P/No	Price Ea Standard	Price Ea Hardfaced
	Kverneland	25.5mm	60mm	10mm	171mm	A-FLNO16		
<b>Y blade suits Kverneland mulcher</b>								
	Kverneland	25.5mm	60mm	10mm	171mm	A-FLNO17		
	<b>Straight blade suits Kverneland mulcher</b>							
	M.E.A.A.T	25.5mm	60mm	10mm	171mm	A-FLNO16		
	<b>Y blade suits M.E.A.A.T TS model mulcher</b>							
	M.E.A.A.T	25.5mm	60mm	10mm	171mm	A-FLNO17		
	<b>Straight blade suits M.E.A.A.T TS model mulcher</b>							
	M.E.A.A.T	25.5mm	60mm	10mm	171mm	A-FLNO15		
	<b>"L" style blade suits M.E.A.A.T TS model mulcher</b>							
	Maletti	25.5mm	60mm	10mm	171mm	A-FLNO16		
	<b>Y blade suits Maletti mulcher</b>							
	Maletti	25.5mm	60mm	10mm	171mm	A-FLNO17		
	<b>Straight blade suits Maletti mulcher</b>							

ATC's range of mulcher flail blades are manufactured in Italy using Boron steel. Tungsten carbide hardfaced blades can be ordered to greatly extend the wear life of the mulching flails.

All pricing is shown as exclusive of GST.



30 day trading account available to approved applicants. Contact Paul for an account application form. Email: paul@atcgroup.com.au

	Make	Hole Size	Width	Thickness	Length	ATC P/No	Price Ea Standard	Price Ea Hardfaced
		Nobili	25.5mm	60mm	10mm	171mm	A-FLNO16	
<b>Y blade suits Nobili BNU, BNG, BK, RM, NK, RMP, RMS models OEM N2555004</b>								
	Nobili	25.5mm	60mm	10mm	171mm	A-FLNO17		
<b>Straight blade suits Nobili BNU, BNG, BK, RM, NK, RMP, RMS models OEM N1551000</b>								
	Nobili	25.5mm	60mm	10mm	171mm	A-FLNO15		
<b>"L" Style blade suits Nobili BNU, BNG, BK, RM, NK, RMP, RMS models OEM N2555001</b>								
	Omarv	25.5mm	60mm	10mm	171mm	A-FLNO16		
<b>Y blade suits Omarv mulcher</b>								
	Omarv	25.5mm	60mm	10mm	171mm	A-FLNO17		
<b>Straight blade suits Omarv mulcher</b>								
	Omarv	25.5mm	60mm	10mm	171mm	A-FLNO15		
<b>"L" Style blade suits Omarv mulcher</b>								
	Sicma	25.5mm	60mm	8mm	118mm	A-FLAG65222		
<b>Y blade suits Sicma mulcher</b>								
	Sicma	25.5mm	60mm	8mm	118mm	A-FLAG84415		
<b>Straight blade suits Sicma mulcher</b>								

All pricing is shown as exclusive of GST.



30 day trading account available to approved applicants. Contact Paul for an account application form. Email: paul@atcgroup.com.au

	Make	Hole Size	Width	Thickness	Length	ATC P/No	Price Ea Standard	Price Ea Hardfaced
	Tierre	25.5mm	60mm	10mm	171mm	A-FLN016		
<b>Y blade suits Tierre TRL mulcher</b>								

	Tierre	25.5mm	60mm	10mm	171mm	A-FLN017		
	<b>Straight blade suits Tierre TRL mulcher</b>							

	Tuffass	25.5mm	60mm	10mm	171mm	A-FLN016		
	<b>Y blade suits Tuffass FTP mulcher</b>							

	Tuffass	25.5mm	60mm	10mm	171mm	A-FLN017		
	<b>Straight blade suits Tuffass FTP mulcher</b>							

## NOTES

MACHINE TYPE	MAKE / MODEL	ATC PART NO	PRICE EA	QUANTITY REQ'D

All pricing is shown as exclusive of GST.



30 day trading account available to approved applicants. Contact Paul for an account application form. Email: paul@atcgroup.com.au

ATC drop forged, cast and profile cut teeth and holders are specifically designed for high ductility and excellent wear. Forged teeth are extremely strong, excellent wearing and exhibit excellent conformity in weight and balance. ATC GROUP drop forged and investment cast teeth and holders are made from high alloy heat treated steel. We make holders for all types of grinders, forest mulchers, groomers and shredders. On request ATC GROUP can tungsten overlay the holders to minimise wear. We then reheat treat the holder to ensure the structural integrity of the steel has not been compromised. We also make custom teeth and holder combinations . We often do this when the OEM combination is not up to the harsh Australian conditions resulting in tip loss.

ATC GROUP also designs and manufactures premium quality wearparts for horizontal grinders, tub grinders, forest mulchers, groomers, shredders, chippers and debarkers. ATC GROUP grinder wearparts are currently in service in the industries involved in wood mulching, wood chipping, forest mulching, stone crushing, sugar processing, tyre shredding, plastic grinding, pet food, fertilizer manufacture and feed lots.

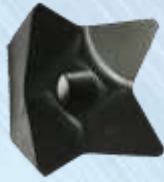
AFE	Advanced Forestry (AFE) Beaver tooth. Suits SS Eco Mulcher, SS Extreme and SS Mini Might mulchers. 2" x 2" shank less with 3/4 NF thread.	Part No I-BT-QH10103T	Price Ea
	Replaces OEM part number SBT-200		
Ahwi	Ahwi style fixed tooth with 2 x tungsten tiles and tungsten overlay. Suits FM, UZM, RM models. OEM part number BFS26. Also suits Fecon.	Part No I-WMF01-2TWC	Price Ea
	Bolt M24 (2.0) x 100mm Cone lock nut M24	F-BHM24(2.0)x100 F-NM24(2.0)Cone	
Ahwi	Ahwi style fixed tooth aggressive version 1 x tungsten tile and tungsten overlay. Suits FM, UZM, RM models. HDT new generation tool equivalent. Also suits Fecon.	Part No I-WMF22-TWC	Price Ea
	Bolt M24 (2.0) x 100mm Cone lock nut M24	F-BHM24(2.0)x100 F-NM24(2.0)Cone	
Ahwi	Ahwi style fixed tooth with 2 x tungsten tiles and tungsten overlay. Suits FM, UZM, RM models. HDT new generation tool equivalent. Also suits Fecon.	Part No I-WMF22-2TWC	Price Ea
	Bolt M24 (2.0) x 100mm Cone lock nut M24	F-BHM24(2.0)x100 F-NM24(2.0)Cone	

References to OEM brands and part numbers are for identification purposes only.  
Items are not sold as original equipment parts.

Email: paul@atcgroup.com.au Phone: 07 3285 7777 Mobile: 0448 588 433



<b>Ahwi</b>	Ahwi style chipper blade base. Suits FM, UZM, RM models. Also suits Fecon. Suit lower horsepower machines	<b>Part No</b> I-WMF22-CHP-Base	<b>Price Ea</b>
	Bolt M24 (2.0) x 100mm Cone lock nut M24	F-BHM24(2.0)x100 F-NM24(2.0)Cone	
<b>Ahwi</b>	Ahwi style chipper blade. Replacement blade for above I-WMF22-CHP-Base. Suits FM, UZM, RM models. Also suits Fecon. Suit lower Hp machines. Standard or hardfaced	<b>Part No</b> I-WMF22-CHP-Knife I-WMF22-CHP-Knife-WC	<b>Price Ea</b>
	2 x Bolt M16 x 40 2 x Schnorr Washer M16	F-BCapM16(2.0)x40 F-WM16 Schnorr	
<b>Auger Torque</b>	Auger Torque VM1500	<b>Part No</b> I-WMF07-3TWC	<b>Price Ea</b>
	Bolt M20 (1.5) x 60mm Washer M20 Schnorr	F-BCapM20(1.5)x60 F-WM20 Schnorr	
<b>Bobcat</b>	Bobcat style 2 bolt and 2 tungsten tiles and tungsten overlay. 5/8" bolts on 42mm centres. Suits FRC50, FRC60, FRC70 models. OEM 698740, 6692660, 6990346	<b>Part No</b> I-WMF11-BC-2TWC	<b>Price Ea</b>
	Bolt 5/8" x 3 1/4" Also 1" Seating Lug WMF11 Bolt 5/8" x 4 1/2" Also M16 Schnorr washer	F-BCap5/8(18)x3-1/4 F-BCap5/8(18)x4-1/2	
<b>Caterpillar</b>	Caterpillar feller buncher beaver tooth suits HFW222CC, HFW232, SC57, SH56B, SS56. Also Prentice, Promac, Quadco and Tigercat. 1" UNF thread.	<b>Part No</b> I-BT-Q10233T	<b>Price Ea</b>
	Bolt 1" x 4"	TBA	TBA
<b>Caterpillar</b>	Caterpillar style fixed tooth 2 bolt with 3 tungsten tiles and tungsten overlay. Suits HM312, HM315 mulchers.	<b>Part No</b> I-WMF06-3TWC	<b>Price Ea</b>
	Bolt M16 (1.5) x 40mm Also 2 x M16 Bolt M16 (1.5) x 70mm Schnorr washer	F-BCapM16(1.5)x40 F-BCapM16(1.5)x70	



Email: paul@atcgroup.com.au Phone: 07 3285 7777 Mobile: 0448 588 433

WEB: www.atcgroup.com.au



<b>Caterpillar</b>	Holder suits Caterpillar 7 1/2" diameter drum on HM312 mulcher	<b>Part No</b> H-WMF06-21S	<b>Price Ea</b>
	Holder suits Caterpillar 12" diameter drum on HM315 mulcher	H-WMF06-21M	
	Bolt M16 (1.5) x 40mm    Also 2 x M16	F-BCapM16(1.5)x40	
	Bolt M16 (1.5) x 70mm    Schnorr washer	F-BCapM16(1.5)x70	
<b>Caterpillar</b>	Caterpillar style fixed tooth 1 bolt with 3 tungsten tiles and tungsten overlay. Suits HM315B, HM415B, MD250, HM825 mulchers. OEM 382-6262	<b>Part No</b> I-WMF07-3TWC	<b>Price Ea</b>
			
	Bolt M20 (1.5) x 60mm	F-BCapM20(1.5)x60	
	Washer M20 Schnorr	F-WM20 Schnorr	
<b>Caterpillar</b>	Caterpillar style fixed tooth 1 bolt with 3 tungsten tiles and tungsten overlay. <b>EHD side scraper</b> . Suits HM315B, HM415B, MD250, HM825 mulchers. OEM 382-6263	<b>Part No</b> I-WMF07-XHD-LH-3TWC I-WMF07-XHD-RH-3TWC	<b>Price Ea</b>
			
	Bolt M20 (1.5) x 60mm	F-BCapM20(1.5)x60	
	Washer M20 Schnorr	F-WM20 Schnorr	
<b>Caterpillar</b>	Holder suits Caterpillar 12" diameter drum on HM415B 12" Drum	<b>Part No</b> H-WMF07	<b>Price Ea</b>
			
	Bolt M20 (1.5) x 60mm	F-BCapM20(1.5)x60	
	Washer M20 Schnorr	F-WM20 Schnorr	
<b>Caterpillar</b>	Caterpillar style fixed tooth 1 bolt with 3 tungsten tiles and tungsten overlay. Suits HM115C, HM215C, HM418C, HM112C, HM315C, HM518, HM415C OEM 475-2810	<b>Part No</b> I-WMF38-3TWC	<b>Price Ea</b>
			
	Special ATC Bolt	F-B-WMF3438-120	
	Cone lock nut / Schnorr Washer	F-NM20x1.5Cone	
<b>Caterpillar</b>	Caterpillar style fixed tooth 1 bolt with 3 tungsten tiles <b>EHD side scraper</b> . Suits HM115C, HM215C, HM418C, HM112C,	<b>Part No</b> I-WMF38-3TWC-XHD-LH I-WMF38-3TWC-XHD-RH	<b>Price Ea</b>
			
	Special ATC Bolt	F-B-WMF3438-120	
	Cone lock nut / Schnorr Washer	F-NM20x1.5Cone	

References to OEM brands and part numbers are for identification purposes only. Items are not sold as original equipment parts.

<p><b>Caterpillar</b></p> 	<p>Reversible planer knife for Caterpillar mulchers fitted with Quadco adapter Q11028-B. 2 bolt adapter on models</p> <p>2 x Bolt 5/8" (18) x 2 1/2"</p>	<p><b>Part No</b></p> <p>I-BT-Q10924T</p> <p>F-BCap5/8(18)x2-1/2</p>	<p><b>Price Ea</b></p>
<p><b>Caterpillar</b></p> 	<p>Planer knife base to suit Caterpillar HM315B, HM415B, MD250, HM825 mulchers. OEM 382-6265.</p> <p>Bolt M20 (1.5) x 60mm</p> <p>Washer M20 Schnorr</p>	<p><b>Part No</b></p> <p>I-WMF33-CHP-Base</p> <p>F-BCapM20(1.5)x60</p> <p>F-WM20 Schnorr</p>	<p><b>Price Ea</b></p>
<p><b>Caterpillar</b></p> 	<p>Planer knife to suit I-WMF33-CHP-Base. Suits Caterpillar HM315B, HM415B, MD250, HM825 mulchers. Available in 55mm or 75mm cutting edge widths</p> <p>2 x Cap head 10mm(1.25) x 25mm</p>	<p><b>Part No</b></p> <p>I-WMF313334-CHP55</p> <p>I-WMF313334-CHP75</p> <p>F-BCapM10(1.25)x25</p>	<p><b>Price Ea</b></p>
<p><b>Caterpillar</b></p> 	<p>Planer knife base to suit Caterpillar HM115C, HM215C, HM418C, HM112C, HM315C, HM518, HM415C</p> <p>Special ATC Bolt</p> <p>Cone lock nut / Schnorr Washer</p>	<p><b>Part No</b></p> <p>I-WMF34-CHP-Base</p> <p>F-B-WMF3438-120</p> <p>F-NM20x1.5Cone</p>	<p><b>Price Ea</b></p>
<p><b>Caterpillar</b></p> 	<p>Planer knife to suit I-WMF34CHP-Base. Suit Caterpillar HM115C, HM215C, HM418C, HM112C, HM315C, HM518, HM415C . Available in 55mm or 75mm cutting edge</p> <p>2 x Cap head 10mm(1.25) x 25mm</p>	<p><b>Part No</b></p> <p>I-WMF313334-CHP55</p> <p>I-WMF313334-CHP75</p> <p>F-BCapM10(1.25)x25</p>	<p><b>Price Ea</b></p>
<p><b>Diamond</b></p> 	<p>Beaver style tooth 1/2" UNF thread. Suits Diamond mulcher head OEM part 22-0019 also suits Diamond mowers skid steer disc mulchers</p> <p>1 x Cap head 1/2 (20) x 3 inch</p>	<p><b>Part No</b></p> <p>I-BT-QH10078T</p> <p>F-BCap1/2(20)x3</p>	<p><b>Price Ea</b></p>



30 day trading account available to approved applicants. Contact Paul for an account application form. Email: paul@atcgroup.com.au

<b>Digga Magnum / Bradco</b>	Digga Magnum / Bradco style fixed tooth 2 bolt with 3 x tungsten tiles and tungsten overlay. Suit MM36, MM60, MM72 OEM 600-112-1 non reversible	<b>Part No</b> I-WMFBM-3TWC	<b>Price Ea</b>
	Bolt M16 x 110mm Bolt M16 x 75mm		
<b>Digga Magnum / Bradco</b>	Digga Magnum / Bradco style fixed tooth 6 tungsten tiles and tungsten overlay. Suit MM36, MM60, MM72 OEM 600-168 Reversible fixed tooth.	<b>Part No</b> I-WMFBM-6T	<b>Price Ea</b>
	Bolt M16 x 110mm Bolt M16 x 75mm		
<b>FAE</b>	FAE A type insert, 2 bolt , 1 x tungsten tile and tungsten overlay. OEM 111431000-K.	<b>Part No</b> I-WMF14-TWC	<b>Price Ea</b>
	EHD side scrapers also available 1 x M16(1.5) x 80mm Also M16 Schnorr 1 x M16(1.5) x 120mm Washer	F-BCapM16(1.5)x80 F-BCapM16(1.5)x120	
<b>FAE</b>	FAE A / F type insert, 2 bolt , 1 x beak tungsten tile and tungsten overlay. Aggressive version. OEM 112800046-K	<b>Part No</b> I-WMF14-BEAK-TWC	<b>Price Ea</b>
	EHD side scrapers also available 1 x M16(1.5) x 80mm Also M16 Schnorr 1 x M16(1.5) x 120mm Washer	F-BCapM16(1.5)x80 F-BCapM16(1.5)x120	
<b>FAE</b>	FAE style holder to suit FAE drum with 190mm radius	<b>Part No</b> H-WMF14	<b>Price Ea</b>
	1 x M16(1.5) x 80mm Also M16 Schnorr 1 x M16(1.5) x 120mm Washer	F-BCapM16(1.5)x80 F-BCapM16(1.5)x120	
<b>FAE</b>	FAE B type insert, 1 bolt , 1 x tungsten tile and tungsten overlay. OEM 111708000-K	<b>Part No</b> I-WMF18-TWC	<b>Price Ea</b>
	EHD side scrapers also available 1 x M24(1.5) x 70mm 1 x M24 Schnorr washer	F-BCapM24(2.0)x70 F-WM24 Schnorr	

FAE	FAE B type insert, 1 bolt , 1 x beak tungsten tile and tungsten overlay. Aggressive version. EHD side scrapers also available.	<b>Part No</b> I-WMF18-BEAK-TWC	<b>Price Ea</b>
	1 x M24(1.5) x 70mm 1 x M24 Schnorr washer	F-BCapM24(2.0)x70 F-WM24 Schnorr	
FAE	FAE C type insert 1 bolt, 3 x tungsten tile and tungsten overlay. OEM 111530012-K	<b>Part No</b> I-WMF07-3TWC	<b>Price Ea</b>
	Bolt M20 (1.5) x 60mm Washer M20 Schnorr	F-BCapM20(1.5)x60 F-WM20 Schnorr	
FAE	FAE C type <b>EHD side scraper</b> insert 1 bolt, 3 x tungsten tile and tungsten overlay. OEM 112700002-K and 112700003-K	<b>Part No</b> I-WMF07-XHD-LH-3TWC I-WMF07-XHD-RH-3TWC	<b>Price Ea</b>
	Bolt M20 (1.5) x 60mm Washer M20 Schnorr	F-BCapM20(1.5)x60 F-WM20 Schnorr	
FAE	FAE C type insert 1 bolt, 1 x beak tungsten tile and tungsten overlay. Aggressive version. EHD side scrapers also available	<b>Part No</b> I-WMF36-TWC	<b>Price Ea</b>
	Bolt M20 (1.5) x 60mm Washer M20 Schnorr	F-BCapM20(1.5)x60 F-WM20 Schnorr	
FAE	Planer knife base to suit FAE D type OEM 112800026-K	<b>Part No</b> I-WMF33-CHP-Base	<b>Price Ea</b>
	Bolt M20 (1.5) x 60mm Washer M20 Schnorr	F-BCapM20(1.5)x60 F-WM20 Schnorr	
FAE	Planer knife to suit I-WMF33-CHP-Base. Suits FAE D type OEM 112800025-K. Available in 55mm or 75mm cutting edge widths	<b>Part No</b> I-WMF313334-CHP55 I-WMF313334-CHP75	<b>Price Ea</b>
	2 x Cap head 10mm(1.25) x 25mm	F-BCapM10(1.25)x25	



ATC drop forged, cast and profile cut hammers and holders are specifically designed for high ductility and excellent wear. ATC Forged hammers are extremely strong, excellent wearing and exhibit excellent conformity in weight and balance.

FAE	Reversible planer knife for FAE mulchers fitted with Quadco adapter Q11028-B 2 bolt adapter	<b>Part No</b> I-BT-Q10924T	<b>Price Ea</b>
	2 x Bolt 5/8" (18) x 2 1/2"	F-BCap5/8(18)x2-1/2	
FAE	FAE style holder to suit FAE drum with 245mm radius.	<b>Part No</b> H-WMF07	<b>Price Ea</b>
	Bolt M20 (1.5) x 60mm Washer M20 Schnorr	F-BCapM20(1.5)x60 F-WM20 Schnorr	
FAE	FAE style C2 tooth 2 bolt with 3 tungsten tiles and tungsten overlay. OEM 111530007-K	<b>Part No</b> I-WMF06-3TWC	<b>Price Ea</b>
	Bolt M16 (1.5) x 40mm    Also 2 x M16 Bolt M16 (1.5) x 70mm    Schnorr washer	F-BCapM16(1.5)x40 F-BCapM16(1.5)x70	
FAE	FAE style C2 tooth 2 bolt with 1 tungsten beak tile and tungsten overlay. Aggressive version.	<b>Part No</b> I-WMF21-TWC	<b>Price Ea</b>
	Bolt M16 (1.5) x 40mm    Also 2 x M16 Bolt M16 (1.5) x 70mm    Schnorr washer	F-BCapM16(1.5)x40 F-BCapM16(1.5)x70	
FAE	2 bolt holder suit FAE drum with 139 radius 2 bolt holder suit FAE drum with 245 radius	<b>Part No</b> H-WMF06-21S H-WMF06-21M	<b>Price Ea</b>
	2 x Bolt M16 (1.5) x 40mm Schnorr washer	F-BCapM16(1.5)x40 F-WM16 Schnorr	
FAE	FAE style K type tooth 1 Bolt with Beak tile. Aggressive cutting. OEM 112800083-K	<b>Part No</b> I-WMF38-BEAK-T	<b>Price Ea</b>
	Special ATC Bolt Cone lock nut Washer	F-B-WMF3438-120 F-NM20x1.5Cone F-WM20Schnorr	

References to OEM brands and part numbers are for identification purposes only. Items are not sold as original equipment parts.

Email: paul@atcgroup.com.au Phone: 07 3285 7777 Mobile: 0448 588 433



<b>FAE</b>	FAE style C3 tooth 1 bolt with 3 tungsten tiles and tungsten overlay. OEM 111530017-K	<b>Part No</b> I-WMF38-3TWC	<b>Price Ea</b>
	Special ATC Bolt Cone lock nut Washer	F-B-WMF3438-120 F-NM20x1.5Cone F-WM20Schnorr	
<b>FAE</b>	FAE style C3 tooth 1 bolt with 3 tungsten tiles and tungsten overlay. EHD side	<b>Part No</b> I-WMF38-3TWC-XHD-LH I-WMF38-3TWC-XHD-RH	<b>Price Ea</b>
	scrapers. OEM 112700004-K and 112700005-K  Special ATC Bolt Cone lock nut Washer	F-B-WMF3438-120 F-NM20x1.5Cone F-WM20Schnorr	
<b>FAE</b>	Planer knife base to suit FAE C3 type OEM 112800070-K	<b>Part No</b> I-WMF34-CHP-Base	<b>Price Ea</b>
	Same fastener kit as shown above.		
<b>FAE</b>	Planer knife to suit I-WMF34-CHP-Base. Suits FAE C3 type OEM 112800069.-K	<b>Part No</b> I-WMF313334-CHP55 I-WMF313334-CHP75	<b>Price Ea</b>
	Available in 55mm or 75mm cutting edge widths  2 x Cap head 10mm(1.25) x 25mm	F-BCapM10(1.25)x25	
<b>FAE</b>	Excavator mulcher E type blade suits DML/HY, DML/HY/VT OEM 112800098-K	<b>Part No</b> I-WMF30	<b>Price Ea</b>
	Bolt M14 x 1.5 x 30mm	F-BCapM14(1.5)x30	
<b>FAE</b>	Excavator mulcher E type heavy duty blade with 3 tungsten tiles suits DML/HY, DML/HY/VT OEM 112800130-K	<b>Part No</b> I-WMF30-3T	<b>Price Ea</b>
	Bolt M14 x 1.5 x 30mm	F-BCapM14(1.5)x30	

All pricing is shown as exclusive of GST.

30 day trading account available to approved applicants. Contact Paul for an account application form. Email: paul@atcgroup.com.au



<b>Fecon</b>	Fecon Viking Sword knife tool	<b>Part No</b> .I-WMF10-SWORD	<b>Price Ea</b>
	3/4 x 3 1/2 Cap Head Bolt Washer M20 Schnorr	F-BCap3/4(16)x3-1/2 F-WM20 Schnorr	
<b>Fecon</b>	Fecon type 2 bolt and 2 tiles and tungsten overlay. Older style 44.45mm hole centres.	<b>Part No</b> I-WMF11-FC-2TWC	<b>Price Ea</b>
	Bolt 5/8" x 3 1/4" Also 1" Seating Lug WMF11 Bolt 5/8" x 4 1/2" Also M16 Schnorr washer	F-BCap5/8(18)x3-1/4 F-BCap5/8(18)x4-1/2	
<b>Fecon</b>	Fecon FGT and DCR rotor type insert. 1 bolt and 3 tiles and tungsten overlay. Suits Bullhog, FM, CEM models.	<b>Part No</b> I-WMF10-3TWC	<b>Price Ea</b>
	3/4 x 3 1/2 Cap Head Bolt Washer M20 Schnorr	F-BCap3/4(16)x3-1/2 F-WM20 Schnorr	
<b>Fecon</b>	Fecon FGT and DCR rotor type insert. EHD side scraper LH and RH. 1 bolt and 3 tiles and tungsten overlay. Suits Bullhog, FM,	<b>Part No</b> I-WMF10-XHD-LH-3TWC I-WMF10-XHD-LH-3TWC	<b>Price Ea</b>
	Bolt 3/4 x 3 1/2" UNF Washer M20 Schnorr	F-BCap3/4(16)x3-1/2 F-WM20 Schnorr	
<b>Fecon</b>	Planer knife base to suit Fecon FGT and DCR rotor type insert. Suits Bullhog, FM, CEM models.	<b>Part No</b> I-WMF31-CHP-Base	<b>Price Ea</b>
	Bolt 3/4 x 3 1/2" UNF Washer M20 Schnorr	F-BCap3/4(16)x3-1/2 F-WM20 Schnorr	
<b>Fecon</b>	Planer knife to suit I-WMF31-CHP-Base. Fecon FGT and DCR rotor type insert. Suits Bullhog, FM, CEM models.	<b>Part No</b> I-WMF313334-CHP55 I-WMF313334-CHP75	<b>Price Ea</b>
	2 x Cap head 10mm(1.25) x 25mm	F-BCapM10(1.25)x25	

ATC GROUP drop forged and investment cast hammers/holders are made from high alloy heat treated steel. We make holders for all types of grinders, forest mulchers, groomers and shredders.

Email: paul@atcgroup.com.au Phone: 07 3285 7777 Mobile: 0448 588 433



<b>John Deere</b>	John Deere insert 2 bolt and 2 tiles and tungsten overlay. Suit MH60 models	<b>Part No</b>	<b>Price Ea</b>
	1" Lug / Metal bush	I-WMF11-JD-2TWC F-WMF11-BUSH	
	Bolt 5/8 x 3 1/4" Also M16 Schnorr	F-BCap5/8(18)x3-3/4	
	Bolt 5/8 x 4 1/2" Washer	F-BCap5/8(18)x4-1/2	
<b>John Deere</b>	Adapter to suit John Deere mulcher for chip blade. Suit MH models	<b>Part No</b>	<b>Price Ea</b>
		H-BT-JD10037	
	Bolt 5/8 x 3 3/4" Also M16 Schnorr	F-BCap5/8(18)x3-1/4	
	Bolt 5/8 x 4 1/2" Washer	F-BCap5/8(18)x4-1/2	
<b>John Deere</b>	Chip blade to suit above John Deere H-BT-JD10037 base	<b>Part No</b>	<b>Price Ea</b>
		I-BT-Q10924T	
	Bolt 5/8 x 3 3/4" Also M16 Schnorr	F-BCap5/8(18)x3-3/4	
	Bolt 5/8 x 4 1/2" Washer	F-BCap5/8(18)x4-1/2	
<b>Gyrotrac</b>	Gyrotrac planer knife style insert suits 500HF, 700HF models	<b>Part No</b>	<b>Price Ea</b>
		I-GYTRC	
	Bolt M20(1.5) x 80mm	F-BCapM20(1.5)x80	
<b>Gyrotrac</b>	Gyrotrac planer knife style insert with tungsten overlay suits 500HF, 700HF models	<b>Part No</b>	<b>Price Ea</b>
		I-GYTRC-WC	
	Bolt M20(1.5) x 80mm	F-BCapM20(1.5)x80	
<b>Gyrotrac</b>	Gyrotrac planer knife style insert with 3 tungsten tiles and tungsten overlay suits 500HF, 700HF models	<b>Part No</b>	<b>Price Ea</b>
		I-GYTRC-3T	
	Bolt M20(1.5) x 80mm	F-BCapM20(1.5)x80	



References to OEM brands and part numbers are for identification purposes only. Items are not sold as original equipment parts.

Email: paul@atcgroup.com.au Phone: 07 3285 7777 Mobile: 0448 588 433



<b>Loftness</b>	Loftness style insert. 2 bolt, with 2 heavy duty tungsten tiles and overlay. OEM N15510 suit G3, G4, CCH 61/71 models	<b>Part No</b> I-WMF16-2TWC	<b>Price Ea</b>
	2 x 5/8(18) x 2 1/2" M16 Schnorr Washer	F-BCap5/8(18)x2-1/2 F-WM16 Schnorr	
<b>Loftness</b>	Loftness planer style insert. 2 bolt, with 2 tungsten tiles and overlay. OEM N17044 suit G3, G4, CCH 61/71 models	<b>Part No</b> I-WMF16-2T-HD-WC	<b>Price Ea</b>
	2 x 5/8(18) x 2 1/2" M16 Schnorr Washer	F-BCap5/8(18)x2-1/2 F-WM16 Schnorr	
<b>Rayco</b>	Rayco style insert 2 bolt with 3 tungsten tiles and tungsten overlay. Suits Rayco C130, C140, C87L, C87FM, XP, FM, models	<b>Part No</b> I-WMF06-3TWC	<b>Price Ea</b>
	Bolt M16 (1.5) x 40mm Also Bolt M16 (1.5) x 70mm Schnorr washer	F-BCapM16(1.5)x40 F-BCapM16x(1.5)x70	
<b>Rayco</b>	Rayco style 2 bolt with 1 tungsten beak tile and tungsten overlay. Aggressive version. Suits Rayco C130, C140, C87L, C87FM, XP, FM	<b>Part No</b> I-WMF21-TWC	<b>Price Ea</b>
	Bolt M16 (1.5) x 40mm Also Bolt M16 (1.5) x 70mm Schnorr washer	F-BCapM16(1.5)x40 F-BCapM16x(1.5)x70	
<b>Rayco</b>	Rayco style insert 2 bolt, 6 tungsten tiles suits C100, C160, C185, C200, C260, T260, T360 models	<b>Part No</b> I-TGB48-6T	<b>Price Ea</b>
	Bolt 5/8"(18) x 3 1/4" Also M16 Bolt 5/8"(18) x 4 1/2" Schnorr washer	F-BCap5/8(18)x3-1/4 F-BCap5/8(18)x4-1/2	
<b>Rayco</b>	Rayco style insert 2 bolt, 6 tungsten tiles and tungsten overlay. Suits C100, C160, C185, C200, C260, T260, T360 models	<b>Part No</b> I-TGB48-6TWC	<b>Price Ea</b>
	Bolt 5/8"(18) x 3 1/4" Also M16 Bolt 5/8"(18) x 4 1/2" Schnorr washer	F-BCap5/8(18)x3-1/4 F-BCap5/8(18)x4-1/2	

All pricing is shown as exclusive of GST.

30 day trading account available to approved applicants. Contact Paul for an account application form. Email: paul@atcgroup.com.au



<b>Rayco</b>	Rayco style insert 2 bolt, with tungsten overlay only. Suits C100, C160, C185, C200, C260, T260, T360 models	<b>Part No</b> I-TGB48-WC	<b>Price Ea</b>
	Bolt 5/8"(18) x 3 1/4" Also M16 Bolt 5/8"(18) x 4" Schnorr washer	F-BCap5/8(18)x3-1/4 F-BCap5/8(18)x4-1/2	
<b>Rayco</b>	Rayco style insert 2 bolt, 8 tungsten tiles suits C100, C160, C185, C200, C260, T260, T360 models	<b>Part No</b> I-TGB48-8T	<b>Price Ea</b>
	Bolt 5/8"(18) x 3 1/4" Also M16 Bolt 5/8"(18) x 4" Schnorr washer	F-BCap5/8(18)x3-1/4 F-BCap5/8(18)x4-1/2	
<b>Rayco</b>	Rayco style insert 2 bolt, 8 tungsten tiles with tungsten overlay suits C100, C160, C185, C200, C260, T260, T360 models	<b>Part No</b> I-TGB48-8T-WC	<b>Price Ea</b>
	Bolt 5/8"(18) x 3 1/4" Also M16 Bolt 5/8"(18) x 4" Schnorr washer	F-BCap5/8(18)x3-1/4 F-BCap5/8(18)x4-1/2	
<b>Seppi</b>	Seppi style insert 2 tungsten tiles tungsten tiles with tungsten overlay. Suit fixed tooth rotors BMS, SMWA, Miniforst, Midiforst,	<b>Part No</b> I-WMF27-2TWC Side Scraper below	<b>Price Ea</b>
	LH Side Scraper RH Side Scraper	I-WMF27-XHD-LH-2TWC I-WMF27-XHD-RH-2TWC	
<b>Seppi</b>	Seppi Style insert with 2 tungsten tiles and hex bolt hole. Suit Miniforst, Midiforst and Midipierre models with fixed inserts.	<b>Part No</b> I-WMF32-WC	<b>Price Ea</b>
	M20 x 1.5 Hex	TBA	TBA

**ATC Group stock other items not listed in this parts catalogue. Please contact Paul if you cannot find the parts you require within our parts catalogue as we are constantly adding new items to our parts range.**



Email: paul@atcgroup.com.au Phone: 07 3285 7777 Mobile: 0448 588 433

WEB: www.atcgroup.com.au

<b>NEW FAE C3 "I" Type</b>	FAE aggressive "I" type insert. OEM Ref 112800082K with tungsten carbide overlay.	<b>Part No</b> I-WMF38-TWC	<b>Price Ea</b>
	Special ATC Bolt Cone lock nut Washer	F-B-WMF3438-120 F-NM20x1.5Cone F-WM20Schnorr	

**NOTES**

MACHINE TYPE	Make / Model	ATC PART NO	PRICE EA	QUANTITY REQ'D

All pricing is shown as exclusive of GST.

30 day trading account available to approved applicants. Contact Paul for an account application form. Email: paul@atcgroup.com.au





## Ground Engaging Wearparts

### Wood Chipper Blades

Chipper blades for;

Morbark

Vermeer

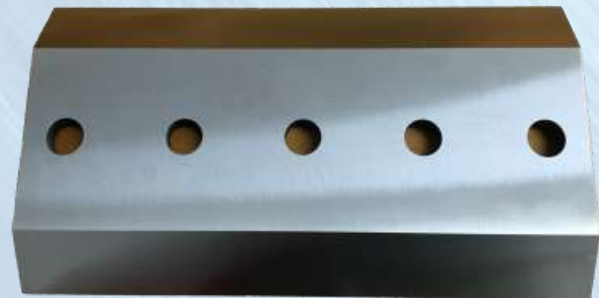

Phone: 07 3285 7777 or Mobile 0448 588 433

Email: [sales@atcgroup.com.au](mailto:sales@atcgroup.com.au) WEB [www.atcgroup.com.au](http://www.atcgroup.com.au)

ATC supply wood chipper blades for Morbark and Vermeer wood chippers. ATC chipper blades are manufactured from A8 modified Swiss tool steel and cryogenically treated. They are supplied with edge protectors and in a safe and convenient carry box at no extra charge.

Brand / ATC Part Number	Model	Price Ea
Morbark / CHKN-39233813	M12R Brush Chipper (12" Drum Chipper)	
Morbark / CHKN-39233813	14 Blizzard Brush Chipper (14" Drum Chipper)	
Morbark / CHKN-39233813	M15R and M15RX Brush Chipper (15" Drum Chipper)	
Morbark / CHKN-39233813	15 Tornado Brush Chipper (15" Drum Chipper)	
Morbark / CHKN-39233813	18 Brush Chipper (18" Drum with Double Edge Knives)	
Morbark / CHKN-39233813	2400XL Hurricane Brush Chipper (18" Drum Chipper)	
Morbark / CHKN-39233813	M18R and M18RX Brush Chipper (18" Drum Chipper)	
Morbark / CHKN-39233813	M20R Brush Chipper (20" Drum with Double Edge Knives)	
Vermeer / CHKN-153175001	BC700 (6" Drum Chipper)	
Vermeer / CHKN-153175001	BC1000 and BC1000XL (12" Drum Chipper)	
Vermeer / CHKN-153175001	BC1200XL (13" Drum Chipper)	



Email: paul@atcgroup.com.au Phone: 07 3285 7777 Mobile: 0448 588 433

WEB: www.atcgroup.com.au

## NOTES

MACHINE TYPE	MAKE / MODEL	ATC PART NO	PRICE EA	QUANTITY REQ'D

All pricing is shown as exclusive of GST.

30 day trading account available to approved applicants. Contact Paul for an account application form. Email: [paul@atcgroup.com.au](mailto:paul@atcgroup.com.au)





## Ground Engaging Wearparts

Slasher blades. Standard replacement or tungsten carbide hardfaced.

Replacement Blade kits for;

Agrifarm

Chris Grow

Daken

Gason

Fieldmaster

Howard

Southern Cross





Phone: 07 3285 7777 or Mobile 0448 588 433

Email: [sales@atcgroup.com.au](mailto:sales@atcgroup.com.au) WEB [www.atcgroup.com.au](http://www.atcgroup.com.au)

Make	Length	Hole	Width	Thick	ATC Part No	Price Ea	Hardfaced
Agrifarm	355mm	32mm	75mm	12mm	A-SBHO24		
	Suits Agrifarm ACS, AES, AHS slashers 40mm step down suction lift blade anticlockwise rotation. Fasteners also available.						

Make	Length	Hole	Width	Thick	ATC Part No	Price Ea	Hardfaced
Chris Grow / Gason	450mm	32mm	100mm	13mm	A-SBCG28		
	Suits various Trailed VHD, Orchard VHD and Delta wing single and multi rotor gearbox mowers. Clockwise rotation RH. OEM Ref MC1500 / 223542						

Make	Length	Hole	Width	Thick	ATC Part No	Price Ea	Hardfaced
Chris Grow / Gason	450mm	32mm	100mm	13mm	A-SBCG29		
	Suits various Trailed VHD, Orchard VHD and Delta wing single and multi rotor gearbox mowers. Anti Clockwise rotation LH. OEM Ref MC1600 / 2235433						

Make	Length	Hole	Width	Thick	ATC Part No	Price Ea	Hardfaced
Chris Grow / Gason	357mm	32mm	100mm	13mm	A-SBCG26		
	Suits various Orchard VHD single and multi rotor gearbox mowers. Clockwise rotation RH. OEM Ref MC1520 / 226511						

Make	Length	Hole	Width	Thick	ATC Part No	Price Ea	Hardfaced
Chris Grow / Gason	355mm	32mm	75mm	12mm	A-SBCG27		
	Suits various Orchard VHD single and multi rotor gearbox mowers. Anticlockwise rotation LH. OEM Ref MC1620 / 226512						

Make	Length	Hole	Width	Thick	ATC Part No	Price Ea	Hardfaced
Chris Grow / Gason	450mm	32mm	100mm	10mm	A-SBCG48		
	Suits Proper Topper 10' and 12' and various models. Clockwise rotation RH. OEM Ref 225158						

Make	Length	Hole	Width	Thick	ATC Part No	Price Ea	Hardfaced
Chris Grow / Gason	450mm	32mm	100mm	10mm	A-SBCG49		
	Suits Proper Topper 10' and 12' and various models. Anticlockwise rotation LH. OEM Ref 225159						

ATC also provide a custom tungsten carbide hardfacing service. With over 20 years experience and robotic and computer aided delivery systems, we are very skilled at what we do. Contact us to discuss your requirements.







Make	Length	Hole	Width	Thick	ATC Part No	Price Ea	Hardfaced
Chris Grow / Gason	357mm	32mm	100mm	10mm	A-SBCG22		
 Suits Proper Topper 8' and Orchard, Rapier, single and multi gearbox rotor mowers. Clockwise rotation RH. OEM Ref MC1525 / 226428							

Make	Length	Hole	Width	Thick	ATC Part No	Price Ea	Hardfaced
Chris Grow / Gason	357mm	32mm	100mm	10mm	A-SBCG23		
 Suits Proper Topper 8' and Orchard, Rapier, single and multi gearbox rotor mowers. Anticlockwise rotation LH. OEM Ref MC1625 / 226427							

Make	Length	Hole	Width	Thick	ATC Part No	Price Ea	Hardfaced
Daken	355mm	32mm	75mm	12mm	A-SBHO24		
 Suction lift blade anticlockwise rotation LH							

Make	Length	Hole	Width	Thick	ATC Part No	Price Ea	Hardfaced
Fieldmaster	357mm	32mm	100mm	10mm	A-SBCG22		
 Suits various Fieldmaster models suction lift blade anticlockwise rotation RH							

Make	Length	Hole	Width	Thick	ATC Part No	Price Ea	Hardfaced
Fieldmaster	357mm	32mm	100mm	10mm	A-SBCG23		
 Suits various Fieldmaster models suction lift blade clockwise rotation LH							

Make	Length	Hole	Width	Thick	ATC Part No	Price Ea	Hardfaced
Howard	355mm	32mm	75mm	12mm	A-SBHO24		
 Suits various Nugget, MD, EHD, EXD slashers suction lift blade anticlockwise rotation LH OEM Ref 78663 Bolt Kits F-SBHO24BK bolt, nut, bush							

Make	Length	Hole	Width	Thick	ATC Part No	Price Ea	Hardfaced
Howard	355mm	32mm	90mm	12mm	A-SBHO43		
 Suction Lift Blade anticlockwise rotation LH OEM Ref 78787KN Leading edge style heavy duty blade. Bolt Kits F-SBHO24BK bolt, nut, bush							



References to OEM brands and part numbers are for identification purposes only. Items are not sold as original equipment parts.

Email: paul@atcgroup.com.au Phone: 07 3285 7777 Mobile: 0448 588 433

Make	Length	Hole	Width	Thick	ATC Part No	Price Ea	Hardfaced
Southern Cross	355mm	32mm	90mm	12mm	A-SBHO24		
 Suits 3'6" and 6" slasher models. Suction lift blade anticlockwise rotation LH							

## NOTES

MACHINE TYPE	Make / model	ATC PART NO	PRICE EA	QUANTITY REQ'D

ATC Group provides a tungsten carbide hardfacing service to greatly extend the life of slasher blades. ATC slasher blades are manufactured from boron 30MNB5 material and can be supplied as a hardfaced blade alternative. Please call to discuss your requirements with us. There are a variety of hardfaced options available.



All pricing is shown as exclusive of GST.

30 day trading account available to approved applicants. Contact Paul for an account application form. Email: paul@atcgroup.com.au



## Ground Engaging Wearparts

Stump grinding teeth  
pockets and fasteners

Replacement stump teeth, holders  
and fasteners for;

Bandit

Bobcat

Carlton

Rayco

Red Roo

Stump Humper

Toro

Vermeer

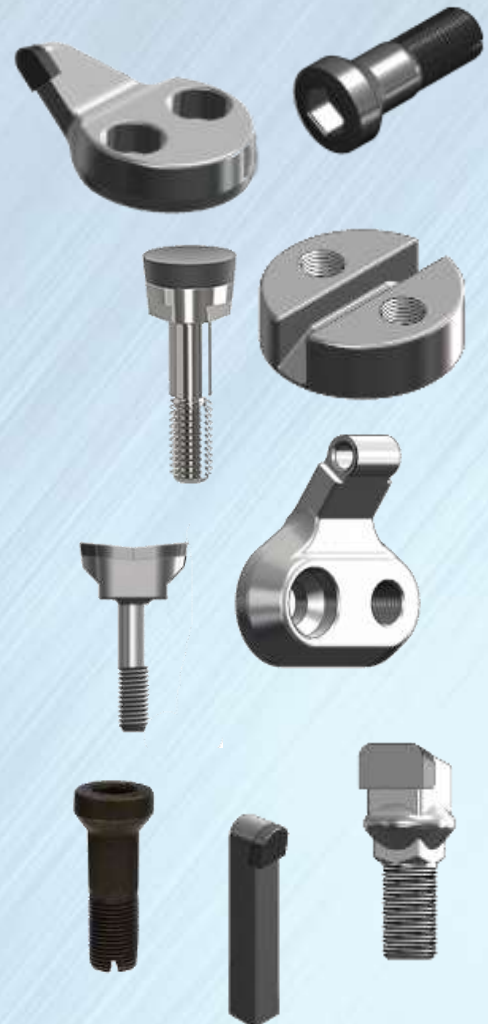

Phone: 07 3285 7777 or Mobile 0448 588 433

Email: [sales@atcgroup.com.au](mailto:sales@atcgroup.com.au) WEB [www.atcgroup.com.au](http://www.atcgroup.com.au)

<p><b>I-BT700-T</b> 52mm high, 21mm diameter tip.</p> 	<p><b>F-W-BT700 Collar</b> <b>F-NC3/8Nyloc Nut</b></p> 	<p><b>Lopro bolts.</b> Refer to fitting guide page 81.</p> 	
---	--	--	--

Brand	Model	I-BT700-T
Bandit	HB19, HB19X, HB20, HB20X	8
Bandit	2100SP, 2150XP, 2250XP	18
Bobcat	23 Hp attachment	16
Rayco	RG9, RG13 Series II	8
Rayco	RRG13, G20HD, RG25HD	12
Rayco	1625 Jr, 1625 Super Jr, RG1631, RG1635 Super Jr, 1635 Trac RG27, RG37, RG37 Trac Jr, RG50	18
Rayco	1635A, 1635D, RG1642, RG1645, 1600M, RG1660M, RG45X, RG45X-R Super Jr, RG45Trac Jr, RG70X, RG74 TR	24
Red Roo	SG350, SH400, SHP400 (SG30TRX, SP4012)	8
Red Roo	SG30TRX, (SP4012 - 20 teeth, 16 angled, 4 straight)	16
Toro	STX26	12
Toro	STX38	16
Vermeer	222	12
Vermeer	630B	12
Vermeer	252, 292, 352	16
Vermeer	206, 630A,	18

<p><b>I-BT900-T</b> 55mm high, 24mm diameter tip.</p> 	<p><b>F-W-BT900 Collar</b> <b>F-NC7/16ConeZ Nut</b></p> 	<p><b>Lopro bolts.</b> Refer to fitting guide page 81.</p> 	
---	---	--	--



Brand	Model	I-BT900-T
Bandit	ZT1844	8
Bandit	2450XP, 2550XP, RG40 Super Jr, RG50	18
Rayco	1635A, 1635D, RG1642, RG1645, 1600M, RG1660M, RG45X, RG45X-R Super Jr, RG45Trac Jr, RG70X, RG74 TR	24
Rayco	RG1665 post 1997, RG1672DXH, 1672M, RG100DX	32
Red Roo	SP7015, SP7015TRX	32
Vermeer	352	20
Vermeer	372, 665B	24
Vermeer	50TX, 60TX, 502, 505, 602	30

**Please be aware: Sharpening of tungsten carbide can be a hazard to your health. The use of suitable breathing apparatus and eye protection is required when sharpening any tungsten carbide product.**

All pricing is shown as exclusive of GST.



**30 day trading account available to approved applicants. Contact Paul for an account application form. Email: paul@atcgroup.com.au**

<p><b>I-BT1100-T</b> 68mm high, 28mm diameter tip.</p> 	<p><b>F-NC1/2ConeZ Nut</b></p> 	<p><b>H-BT1100-ANGLE</b> Supplied in threaded and counter bored</p> 	<p><b>H-BT1100-STRAIGHT</b> Supplied in threaded and counter bored</p> 	<p>Cap head bolts. Refer to fitting guide page 81.</p> 
--	--	---	--	--

Brand	Model	I-BT1100-T	H-BT1100 ANGLE	H-BT1100 STRAIGHT
Bandit	2890XP, 2900 Tracked	24	20	4
Bandit	2800XP, 3400XP	32	28	4
Bandit	3200XP	48	44	4
Rayco	RG37 Super Jr, RG66, RG85	24	18	6
Rayco	RG1665 post 1997, RG1672DXH, 1672M, RG100DX	32	28	4
Rayco	RG70, RG100, RG100R	36	28	8
Rayco	RG106DXH, RG120DXH, RG140DXH	40	36	4
Red Roo	SP8018 TRX	32	28	4
Vermeer	652, 852, SC852	26	22	4
Vermeer	672	28	24	4
Vermeer	1152	32	28	4
Vermeer	752, 802	36	32	4
Vermeer	1102	48	44	4

Can't see the model you required listed? Contact us and we will do our best to assist you with any enquiry you may have. ATC are committed to customer service and will do our best to assist you!

References to OEM brands and part numbers are for identification purposes only. Items are not sold as original equipment parts.

Email: paul@atcgroup.com.au Phone: 07 3285 7777 Mobile: 0448 588 433



<p><b>I-BTHORNET</b> 52mm high, 21mm diameter tip.</p> 	<p><b>F-NC3/8ConeZ</b> F-NC3/8N Nyloc Nut</p> 	<p><b>H-BT-HORNET-ANGLE</b> 39mm hole centres. Reversible holder.</p> 	<p><b>H-BT-HORNET-STRAIGHT</b> 39mm hole centres. Reversible holder</p> 	<p>Cap head bolts. Refer to fitting guide page 81.</p> 
--	---	---	---	--

Brand	Model	I-BTHORNET	H-BTHORNET Angled	H-BTHORNET Straight
Vermeer	222	12	6	6
Vermeer	630B	12	10	2
Vermeer	252, 292, SC292, 362, SC362, SC30TX	16	12	4
Vermeer	206, 630A	18	16	2
Vermeer	352, SC40TX, SC382	20	16	4
Vermeer	372, 665B	24	20	4
Vermeer	SC552, 652, 852, SC852,	26	22	4
Vermeer	672	28	24	4
Vermeer	50TX, 60TX, 502, 505, 602, SC70TX,	30	26	4
Vermeer	665. 1152	32	24	8
Vermeer	752, 802, SC802	42	38	4
Vermeer	1102	48	44	4

Note: Fitment of 700 and 900 and 1100 series stump grinder teeth to Vermeer models. Vermeer come fitted with original “Yellowjacket teeth” and Vermeer holders. However the range of I-BT700 and I-BT900 and I-BT100 teeth can be fitted by replacing the original Vermeer holders with ATC H-BT700 and H-BT900 and H-BT1100 angled and straight holders. The hole centres of the original Vermeer holders are the same as the ATC H-BT700 and H-BT900

All pricing is shown as exclusive of GST.



30 day trading account available to approved applicants. Contact Paul for an account application form. Email: paul@atcgroup.com.au

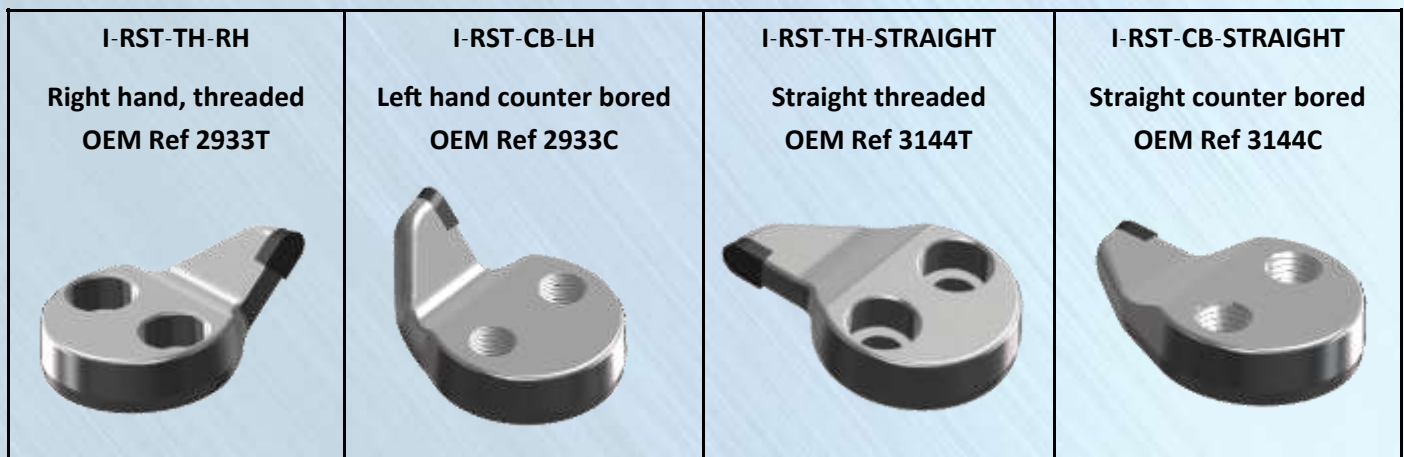

Brand	Model	I-RST-TH-RH	I-RST-CB-LH	I-RST-TH-STRAIGHT	I-RST-CB-STRAIGHT
Rayco	RG9, RG13 Series II	2	2	2	2
Rayco	RG13, RG20HD, RG25HD	3	3	3	3
Rayco	1625 Jr, 1625 Super Jr, RG1631, RG1635 Super Jr, 1635 Trac RG27, RG37, RG37 Trac Jr, RG50	6	6	3	3
Rayco	RG37 Super Jr, RG66, RG85	9	9	3	3
Rayco	1635A, 1635D, RG1642, RG1645, 1600M, RG1660M, RG45X, RG45X-R Super Jr, RG45Trac Jr, RG70X, RG74 TR	10	10	2	2
Rayco	RG1665 post 1997, RG1672DXH, 1672M, RG100DX	14	14	2	2
Rayco	RG70, RG100, RG100R	16	16	2	2
Rayco	RG106DXH, RG120DXH, RG140DXH	18	18	2	2



Can't see the model you required listed? Contact us and we will do our best to assist you with any enquiry you may have. ATC are committed to customer service and will do our best to assist you!



References to OEM brands and part numbers are for identification purposes only. Items are not sold as original equipment parts.

Email: paul@atcgroup.com.au Phone: 07 3285 7777 Mobile: 0448 588 433



<p><b>I-ST-SCN</b> 1/2" stump teeth neutral</p> 	<p><b>I-ST-SCL</b> 1/2" stump teeth left hand</p> 	<p><b>I-ST-SCR</b> 1/2" stump teeth right hand</p> 	<p><b>H-ST-BLK-TH</b> Holder 1/2" threaded 38mm hole centres</p> 	<p><b>H-ST-BLK-CB</b> Holder 1/2" counter bored. 38mm hole centres</p> 
---	---	--	---	--

Above 1/2" Stump grinding teeth will suit a large range of stump grinders, excellent for low hp applications. Holders to suit are industry standard with 38mm hole centres.

CAP HEAD BOLTS - WHEEL THICKNESS	REQUIRED BOLT LENGTH	ATC PART NUMBER	PRICE EA
1/2" (12.70mm)	2" (50.80mm)	F-BCAP5/8(18)x2	
3/4" (19.05mm)	2-1/4" (57.15mm)	F-BCAP5/8(18)x2-1/4	
1" (25.40mm)	2-1/2" (63.50mm)	F-BCAP5/8(18)x2-1/2	
1-1/8" (28.58mm)	2-3/4" (69.85mm)	F-BCAP5/8(18)x2-3/4	
1-1/2" (38.10mm)	3" (76.20mm)	F-BCAP5/8(18)x3	

Cap Head Bolts are in the above table. Lopro bolts are in the below table. Note: Cap Head Bolts are measured from under the head and Lopro Bolts are measured including head.



Use 1/2" Allen key drive torque to 180-200FT/LBS

LOPRO BOLTS - WHEEL THICKNESS	REQUIRED BOLT LENGTH	ATC PART NUMBER	PRICE EA
1/2" (12.70mm)	2" (50.80mm)	F-BLCAP5/8(18)x2	
3/4" (19.05mm)	2-1/4" (57.15mm)	F-BLCAP5/8(18)x2-1/4	
1" (25.40mm)	2-1/2" (63.50mm)	F-BLCAP5/8(18)x2-1/2	
1-1/8" (28.58mm)	2-3/4" (69.85mm)	F-BLCAP5/8(18)x2-3/4	
1-1/2" (38.10mm)	3" (76.20mm)	F-BLCAP5/8(18)x3	

All pricing is shown as exclusive of GST.

30 day trading account available to approved applicants. Contact Paul for an account application form. Email: paul@atcgroup.com.au





## Ground Engaging Wearparts

### Fasteners

- Hex Head Bolts
- Plow Bolt
- Cap Screw Bolts
- UNC Nuts
- Cone Lock Nuts
- Elliptical Nuts
- Flat Washers
- Schnorr Washers
- U-Bolts



Phone: 07 3285 7777 or Mobile 0448 588 433

Email: [sales@atcgroup.com.au](mailto:sales@atcgroup.com.au) WEB [www.atcgroup.com.au](http://www.atcgroup.com.au)



Plow bolts, UNC nuts, UNC cone lock nuts , and elliptical lock nuts are stocked. Minimum 170,000 PSI tensile strength - 14% higher than SAE requirement

UNC



Cone Lock



Elliptical

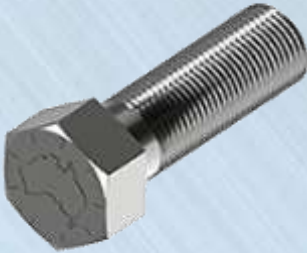
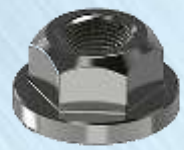

Hex head bolts, UNC nuts, UNC cone lock nuts , and elliptical lock nuts are stocked. Minimum 170,000 PSI tensile strength - 14% higher than SAE requirement

UNC



Cone Lock



Elliptical

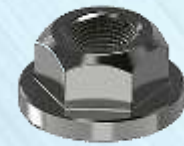

Cap head bolts available in a wide range of sizes. ATC also stock a comprehensive range of standard washers and schnorr washers

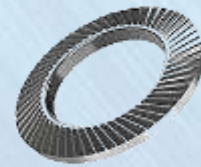
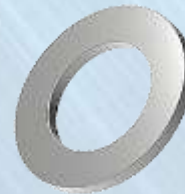

Contact ATC for your fastener requirements.



The last few years have seen the world become a smaller place. Easier access to China through the web and low end resellers mean wearparts have drastically come down in price. Some parts have never been cheaper.

There is though, a huge difference between cheap parts at a cheap price and premium parts at a great price. This is the main difference that separates ATC GROUP from the rest. Our products are the highest quality, International standard parts specially manufactured with Australian conditions in mind.

All pricing is shown as exclusive of GST.

30 day trading account available to approved applicants.



U-Bolts		A	B	C	D	
ATC P/No	RHS Side	Thread	Inside Width	Length	Thread Length	Price Each
F-AUB35X35-58	3.5" X 3.5"	5/8"	91	130	45	
F-AUB35X35-34	3.5" X 3.5"	3/4"	91	140	35	
F-AUB4X4-58	4" X 4"	5/8"	102	155	50	
F-AUB4X4-34	4" X 4"	3/4"	102	150	55	
F-AUB4X4-1	4" X 4"	1"	101	150	35	
F-AUB4X6-34	4" X 6"	3/4"	102	200	55	
F-AUB6X4-58	6" X 4"	5/8"	152	140	45	
F-AUB6X4-34	6" X 4"	3/4"	152	150	55	
F-AUB6X6-58	6" X 6"	5/8"	152	190	45	
F-AUB6X6-34	6" X 6"	3/4"	152	200	55	
F-AUB6X6-1	6" X 6"	1"	152	200	55	
F-AUB7X7-58	7" X 7"	5/8"	180	220	45	
F-AUB7X7-34	7" X 7"	3/4"	180	230	55	
F-AUB7X7-78	7" X 7"	7/8"	179	230	35	
F-AUB7X7-78L	7" X 7"	7/8"	179	250	50	
F-AUB8X4-34	8" X 4"	3/4"	202	150	55	
F-AUB8X8-58	8" X 8"	5/8"	202	240	45	
F-AUB8X8-34	8" X 8"	3/4"	202	250	55	
F-AUB8X8-78	8" X 8"	7/8"	202	267	64	

U-Bolts are sold including spring washers and nuts. Note that the length "C" dimensions in the table above includes thread length.

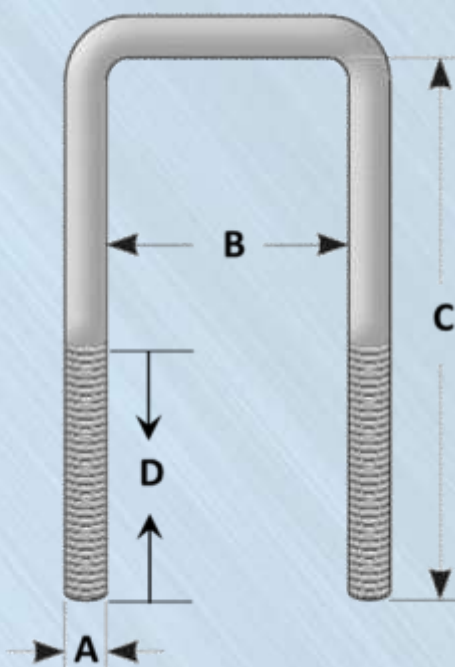

All pricing is shown as exclusive of GST.

30 day trading account available to approved applicants. Contact Paul for an account application form. Email: paul@atcgroup.com.au



# NOTES

MACHINE TYPE	MAKE / MODEL	ATC PART NO	PRICE EA	QUANTITY REQ'D

All pricing is shown as exclusive of GST.

**30 day trading account available to approved applicants. Contact Paul for an account application form. Email: paul@atcgroup.com.au**





## HOW TO ORDER

### ORDERING

- Orders can be placed by, email or phone, and we do not require any minimum invoice value. Please note all prices listed in our wearparts components catalogue are exclusive of GST.
- All published prices are subject to change without prior notice.

### PAYMENTS

- ATC GROUP do make available to approved customers, 30 day after end of month trade accounts. For an account application form please contact Paul via email [paul@atcgroup.com.au](mailto:paul@atcgroup.com.au) or phone our office on 07 3285 7777.
- For non account holders, ATC GROUP accept credit card payments via MasterCard and Visa. ATC GROUP do not store records of your credit card details. Payment by direct deposit via EFT is also available. Our account details and BSB are listed on all invoices.
- ATC GROUP accept payment by cheque for account holders only. Our postal address is ATC GROUP 7/34 Paisley Drive, Lawnton Queensland 4501.

### SHIPPING OF ORDERS

- ATC GROUP delivers orders Australia wide using a variety of shipping companies and all freight charges are clearly quoted prior to despatch of orders. ATC GROUP have developed partnerships with major transport companies and always endeavour to provide you with the most competitive freight rates available for your geographic location. ATC GROUP use Australia post for smaller orders. Bulk orders can be delivered to transport depots for collection.
- Orders for standard/blanks parts are generally shipped the next business day.
- Orders for parts with tungsten carbide/chromium carbide overlay hard facing are usually despatched within 4 business days.

### TRADING HOURS

- ATC GROUP can be contacted from 8.30am to 5pm Monday to Friday. We are closed on public holidays and for a short time over the Christmas break.

**Phone: 07 3285 7777 or Mobile 0448 588 433**

**Email: [sales@atcgroup.com.au](mailto:sales@atcgroup.com.au) WEB [www.atcgroup.com.au](http://www.atcgroup.com.au)**

# WARRANTY



## WARRANTY POLICY

- When purchasing goods from ATC GROUP, customers are entitled to assume;
- The goods being purchased are of a satisfactory quality.
- The goods are fit for all purposes for which they are intended.
- The goods are safe and durable.
- That where any written description is applied to the good, that they match that description.
- Of course ATC GROUP engineers want to solve any issue, so we may ask for the parts to be returned or want to discuss fitment / adapter issues. Some breakages, such as those caused by grinding quartz with your tungsten tipped stump grinder teeth or trying to drill through a buried gearbox with your 8mm auger teeth are not ATC GROUP's fault. For us to keep supplying high quality parts at these great prices we need fair minded customers.

## RETURNS POLICY

- If the product you choose has been wrongly described, different to the product purchased or doesn't perform as advertised – you are entitled to a refund. In this case ATC GROUP would pay the return freight.
- Please choose carefully as we don't give refunds if you just change your mind. That said, we understand sometimes between the machine operator and procurement, errors are made. The wrong parts get ordered etcetera. If this occurs call us or send us an email, explain the situation and we will do our best to help. The customer would bear the cost of returning the freight if the error was not ours.
- Parts must be returned in the same condition that they are supplied, and received by ATC GROUP within 21 days of being received by the customer.
- Our products are all the highest quality, international standard parts specially manufactured with Australian conditions in mind.

© This catalogue is copyright. Apart from any use permitted under the Copyright Act 1968, no part may be reproduced by any process, nor may any other exclusive right be exercised, without the written permission of ATC GROUP.

**Phone: 07 3285 7777 or Mobile 0448 588 433**

**Email: [sales@atcgroup.com.au](mailto:sales@atcgroup.com.au) WEB [www.atcgroup.com.au](http://www.atcgroup.com.au)**

**March 2025**

# WEARPARTS CATALOGUE



Standard replacement wearparts  
and **tungsten carbide hard faced**  
**wearparts** for

**AGRICULTURE, HORTICULTURE, VITICULTURE**



**FORESTRY, ARBORIST, MULCH, CHIP, GRIND**



**DRILLING, TRENCHING**



**ATC Group**  
Unit 16, 31-79 Paisley  
Drive, Lawnton, QLD  
4501.

ABN 40 414 770 743

[www.atcgroup.com.au](http://www.atcgroup.com.au)

**PH: 07 3285 7777**

**MOB: 0448 588 433**

**EMAIL: [paul@atcgroup.com.au](mailto:paul@atcgroup.com.au)**

